

[Tutorials](#) | [Exercises](#) | [Abstracts](#) | [LC Workshops](#) | [Comments](#) | [Search](#) | [Privacy & Legal Notice](#)
[Tutorials](#) | [Exercises](#) | [Abstracts](#) | [LC Workshops](#) | [Comments](#) | [Search](#) | [Privacy & Legal Notice](#)

Introduction to Parallel Computing

Blaise Barney, Lawrence Livermore National Laboratory

Table of Contents

1. [Abstract](#)
2. [Overview](#)
 1. [What is Parallel Computing?](#)
 2. [Why Use Parallel Computing?](#)
 3. [Concepts and Terminology](#)
 1. [von Neumann Computer Architecture](#)
 2. [Flynn's Classical Taxonomy](#)
 3. [Some General Parallel Terminology](#)
 4. [Parallel Computer Memory Architectures](#)
 1. [Shared Memory](#)
 2. [Distributed Memory](#)
 3. [Hybrid Distributed-Shared Memory](#)
 5. [Parallel Programming Models](#)
 1. [Overview](#)
 2. [Shared Memory Model](#)
 3. [Threads Model](#)
 4. [Message Passing Model](#)
 5. [Data Parallel Model](#)
 6. [Other Models](#)
 6. [Designing Parallel Programs](#)
 1. [Automatic vs. Manual Parallelization](#)
 2. [Understand the Problem and the Program](#)
 3. [Partitioning](#)
 4. [Communications](#)
 5. [Synchronization](#)

6. [Data Dependencies](#)
7. [Load Balancing](#)
8. [Granularity](#)
9. [I/O](#)
10. [Limits and Costs of Parallel Programming](#)
11. [Performance Analysis and Tuning](#)
7. [Parallel Examples](#)
 1. [Array Processing](#)
 2. [PI Calculation](#)
 3. [Simple Heat Equation](#)
 4. [1-D Wave Equation](#)
8. [References and More Information](#)

Abstract

This tutorial covers the very basics of parallel computing, and is intended for someone who is just becoming acquainted with the subject. It begins with a brief overview, including concepts and terminology associated with parallel computing. The topics of parallel memory architectures and programming models are then explored. These topics are followed by a discussion on a number of issues related to designing parallel programs. The tutorial concludes with several examples of how to parallelize simple serial programs.

Level/Prerequisites: None

Overview

What is Parallel Computing?

- Traditionally, software has been written for *serial* computation:
 - To be run on a single computer having a single Central Processing Unit (CPU);
 - A problem is broken into a discrete series of instructions.
 - Instructions are executed one after another.
 - Only one instruction may execute at any moment in time.

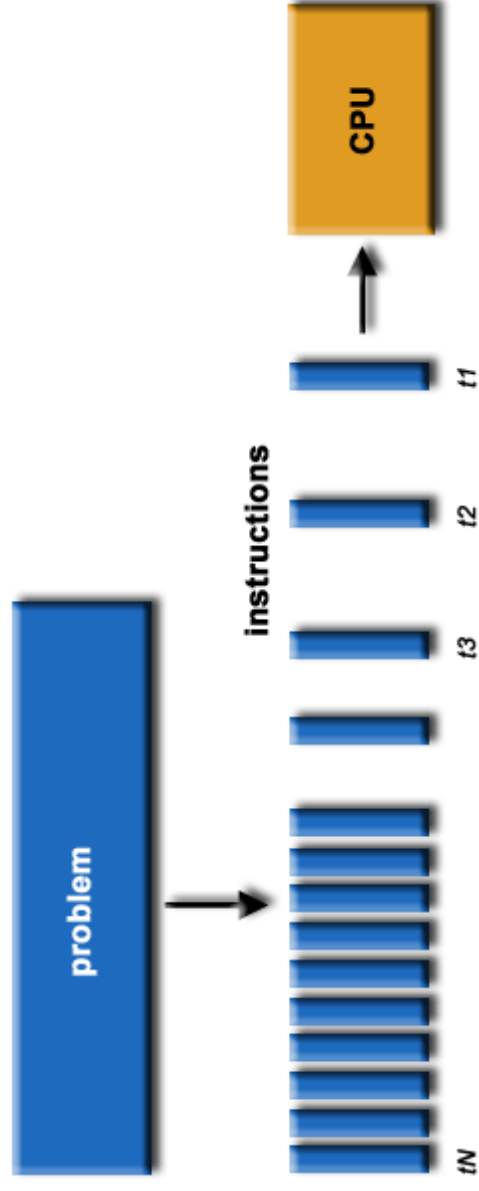

• In the simplest sense, *parallel computing* is the simultaneous use of multiple compute resources to solve a computational problem:

- To be run using multiple CPUs
- A problem is broken into discrete parts that can be solved concurrently
- Each part is further broken down to a series of instructions
- Instructions from each part execute simultaneously on different CPUs

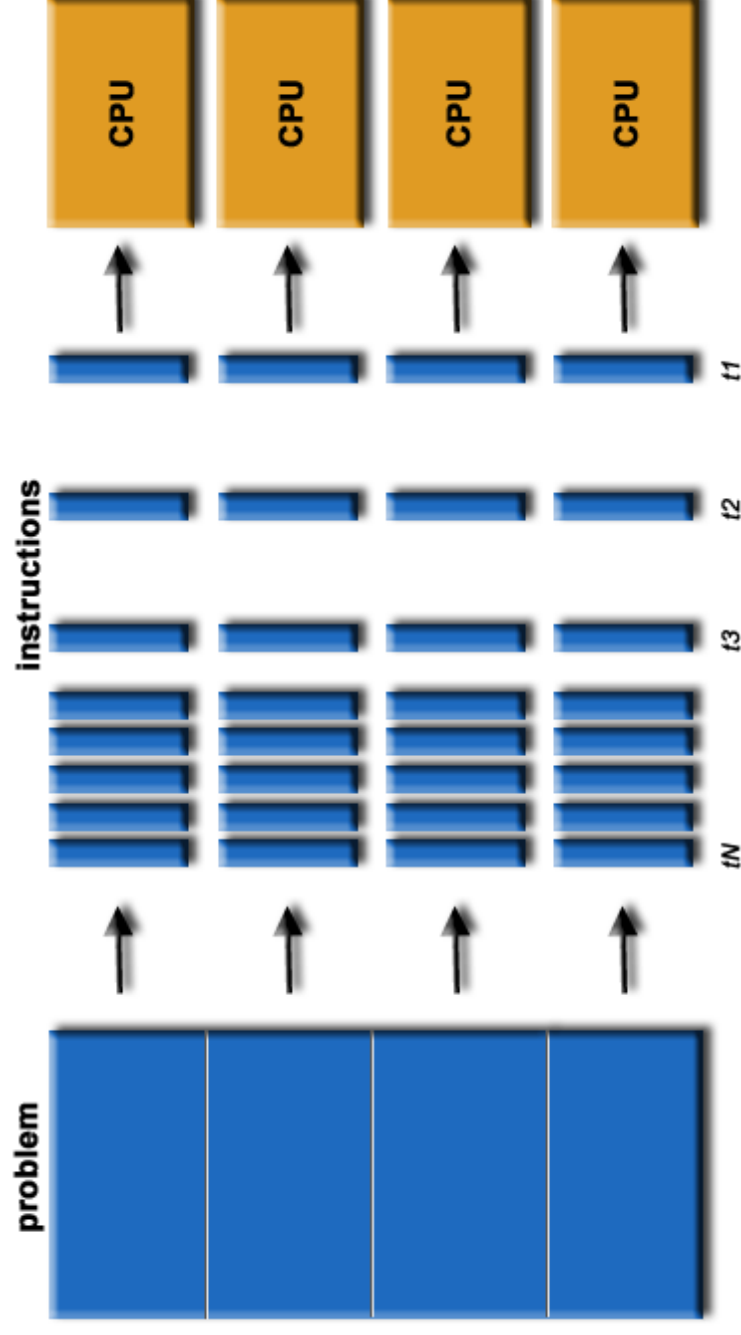

- The compute resources can include:
 - A single computer with multiple processors;
 - An arbitrary number of computers connected by a network;
 - A combination of both.
- The computational problem usually demonstrates characteristics such as the ability to be:
 - Broken apart into discrete pieces of work that can be solved simultaneously;
 - Execute multiple program instructions at any moment in time;
 - Solved in less time with multiple compute resources than with a single compute resource.

► The Universe is Parallel:

- Parallel computing is an evolution of serial computing that attempts to emulate what has always been the state of affairs in the natural world: many complex, interrelated events happening at the same time, yet within a sequence. For example:
 - Galaxy formation
 - Planetary movement
 - Weather and ocean patterns
 - Rush hour traffic
 - Automobile assembly line
 - Building a space shuttle

- o Tectonic plate drift
- o Ordering a hamburger at the drive through.

The Real World is Massively Parallel

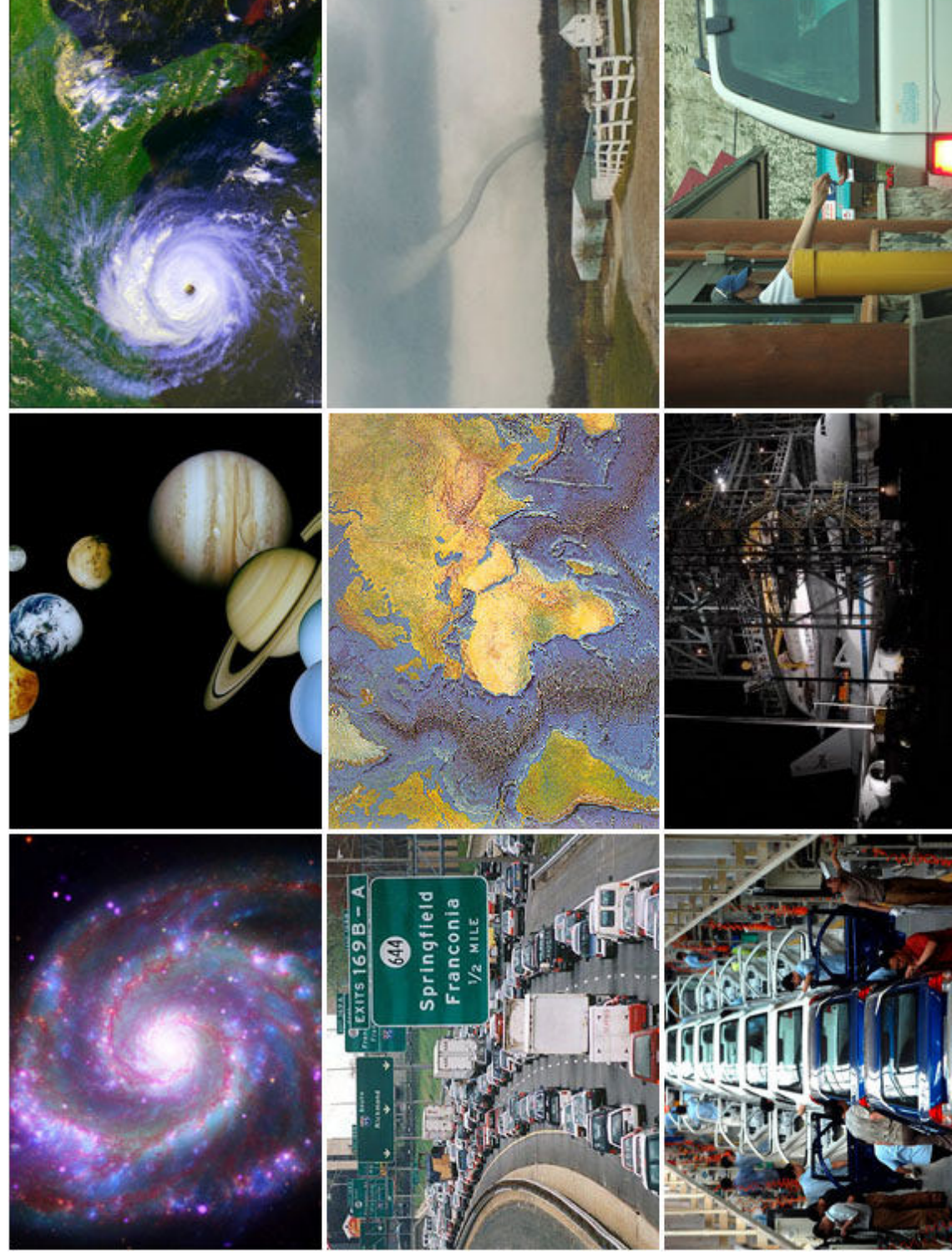

▲ Uses for Parallel Computing:

- Historically, parallel computing has been considered to be "the high end of computing", and has been used to model difficult scientific and engineering problems

found in the real world. Some examples:

- Atmosphere, Earth, Environment
- Physics - applied, nuclear, particle, condensed matter, high pressure, fusion, photonics
- Bioscience, Biotechnology, Genetics
- Chemistry, Molecular Sciences
- Geology, Seismology
- Mechanical Engineering - from prosthetics to spacecraft
- Electrical Engineering, Circuit Design, Microelectronics
- Computer Science, Mathematics

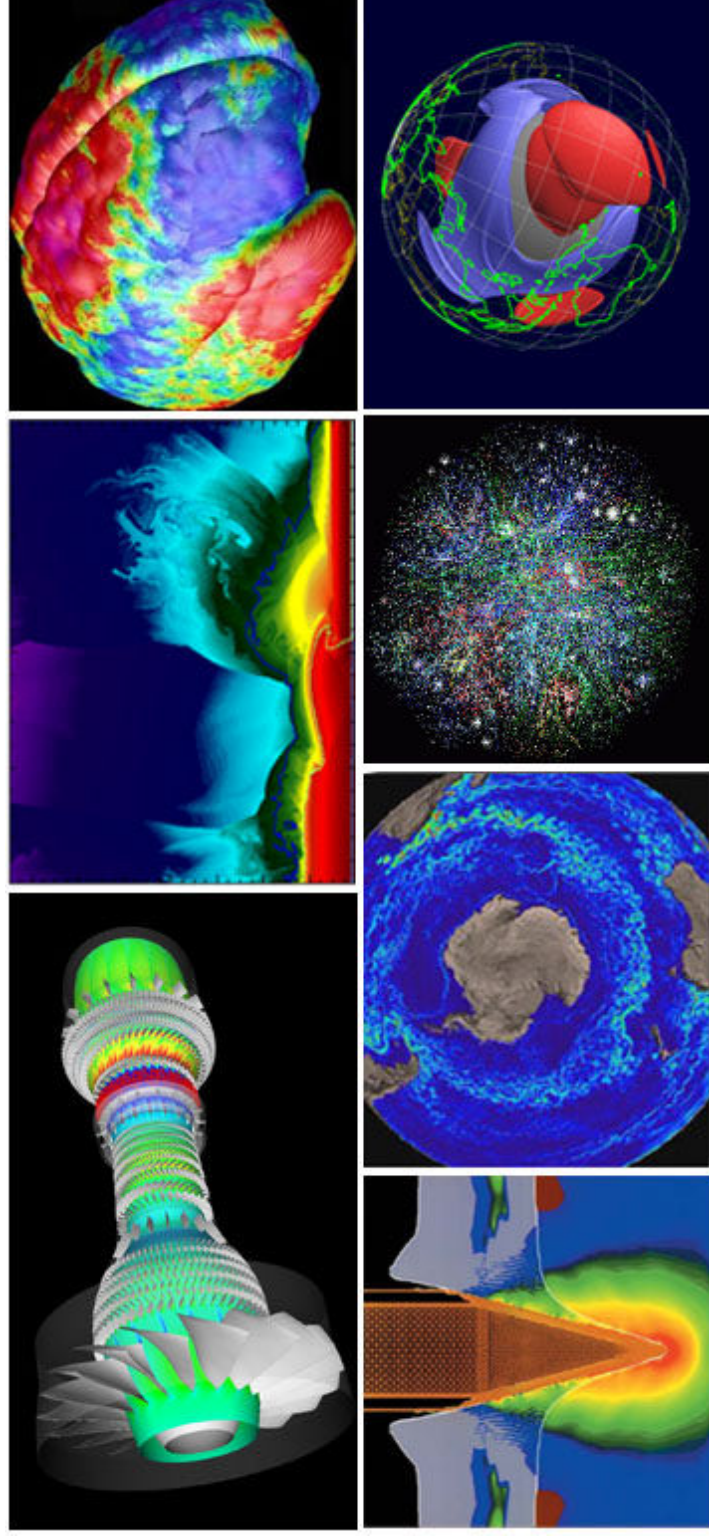

- Today, commercial applications provide an equal or greater driving force in the development of faster computers. These applications require the processing of large amounts of data in sophisticated ways. For example:
 - Databases, data mining
 - Oil exploration
 - Web search engines, web based business services
 - Medical imaging and diagnosis
 - Pharmaceutical design
 - Management of national and multi-national corporations
 - Financial and economic modeling

- o Advanced graphics and virtual reality, particularly in the entertainment industry
- o Networked video and multi-media technologies
- o Collaborative work environments

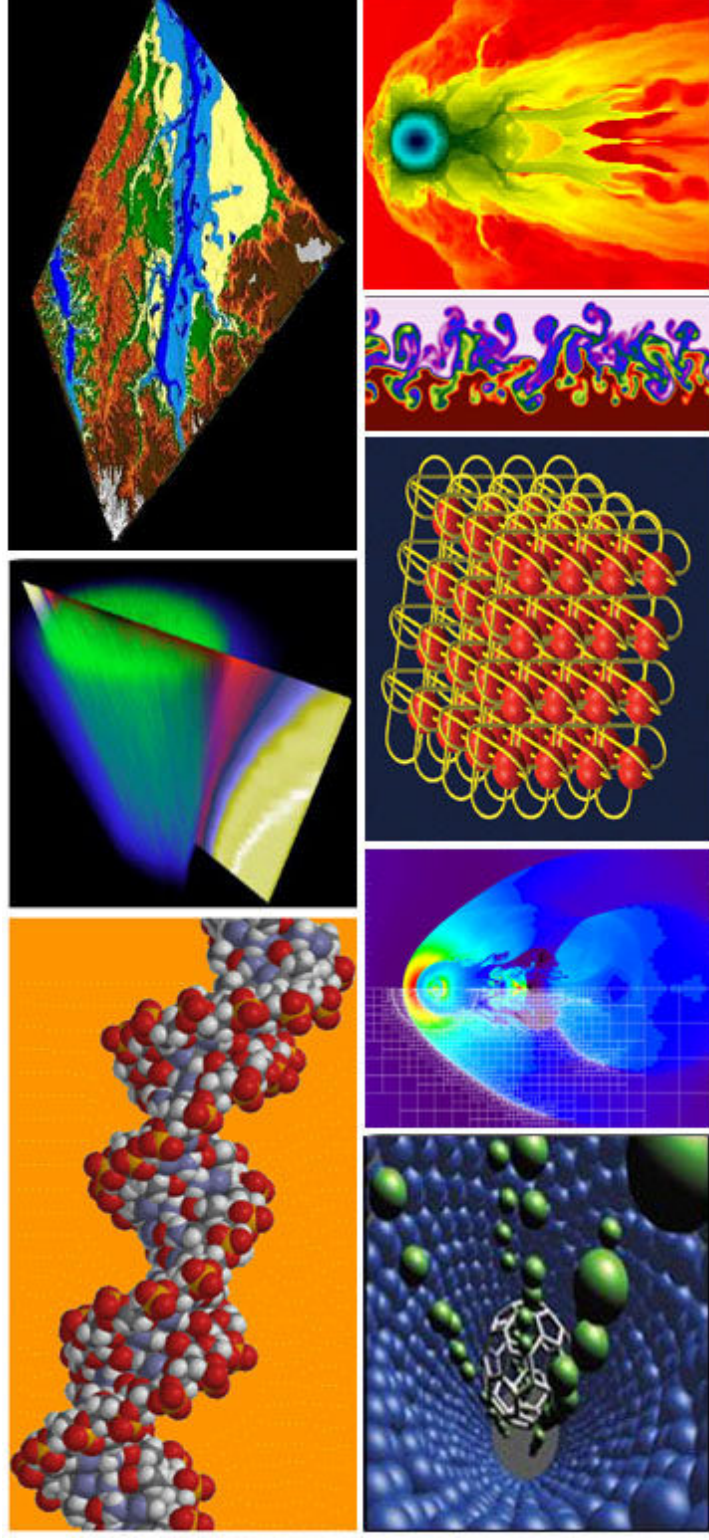

Overview

Why Use Parallel Computing?

► Main Reasons:

- **Save time and/or money:** In theory, throwing more resources at a task will shorten its time to completion, with potential cost savings. Parallel clusters can be built from cheap, commodity components.

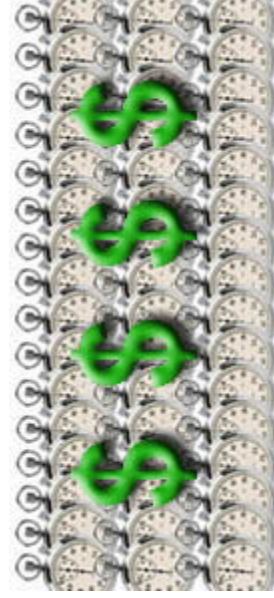

- **Solve larger problems:** Many problems are so large and/or complex that it is impractical or impossible to solve them on a single computer, especially given limited computer memory. For example:
 - "Grand Challenge" (en.wikipedia.org/wiki/Grand_Challenge) problems requiring PetaFLOPS and PetaBytes of computing resources.
 - Web search engines/databases processing millions of transactions per second



- **Provide concurrency:** A single compute resource can only do one thing at a time. Multiple computing resources can be doing many things simultaneously. For example, the Access Grid (www.accessgrid.org) provides a global collaboration network where people from around the world can meet and conduct work "virtually".



- **Use of non-local resources:** Using compute resources on a wide area network, or even the Internet when local compute resources are scarce. For example:
 - SETI@home (setiathome.berkeley.edu) uses over 330,000 computers for a compute power over 528 TeraFLOPS (as of August 04, 2008)
 - Folding@home (folding.stanford.edu) uses over 340,000 computers for a compute power of 4.2 PetaFLOPS (as of November 4, 2008)



- **Limits to serial computing:** Both physical and practical reasons pose significant constraints to simply building ever faster serial computers:
 - Transmission speeds - the speed of a serial computer is directly dependent upon how fast data can move through hardware. Absolute limits are the speed of light (30 cm/nanosecond) and the transmission limit of copper wire (9 cm/nanosecond). Increasing speeds necessitate increasing proximity of processing elements.
 - Limits to miniaturization - processor technology is allowing an increasing number of transistors to be placed on a chip. However, even with molecular or atomic-level components, a limit will be reached on how small components can be.
 - Economic limitations - it is increasingly expensive to make a single processor faster. Using a larger number of moderately fast commodity processors to achieve the same (or better) performance is less expensive.

Current computer architectures are increasingly relying upon hardware level parallelism to improve performance:

- Multiple execution units
- Pipelined instructions
- Multi-core

▶ Who and What?

- Top500.org provides statistics on parallel computing users - the charts below are just a sample. Some things to note:
 - Sectors may overlap - for example, research may be classified research. Respondents have to choose between the two.
 - "Not Specified" is by far the largest application - probably means multiple applications.

Who's Doing Parallel Computing?

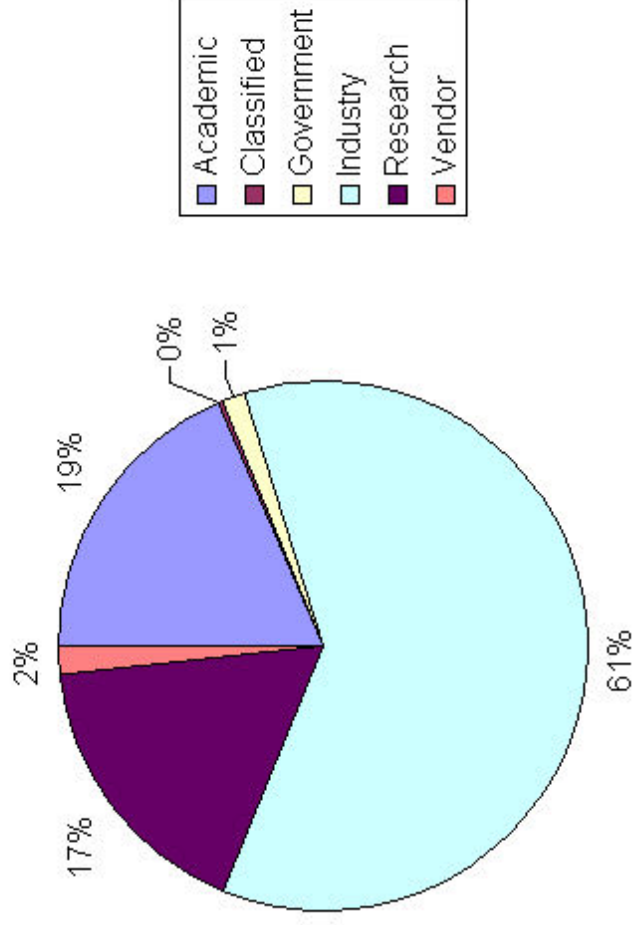

What Are They Using it For?

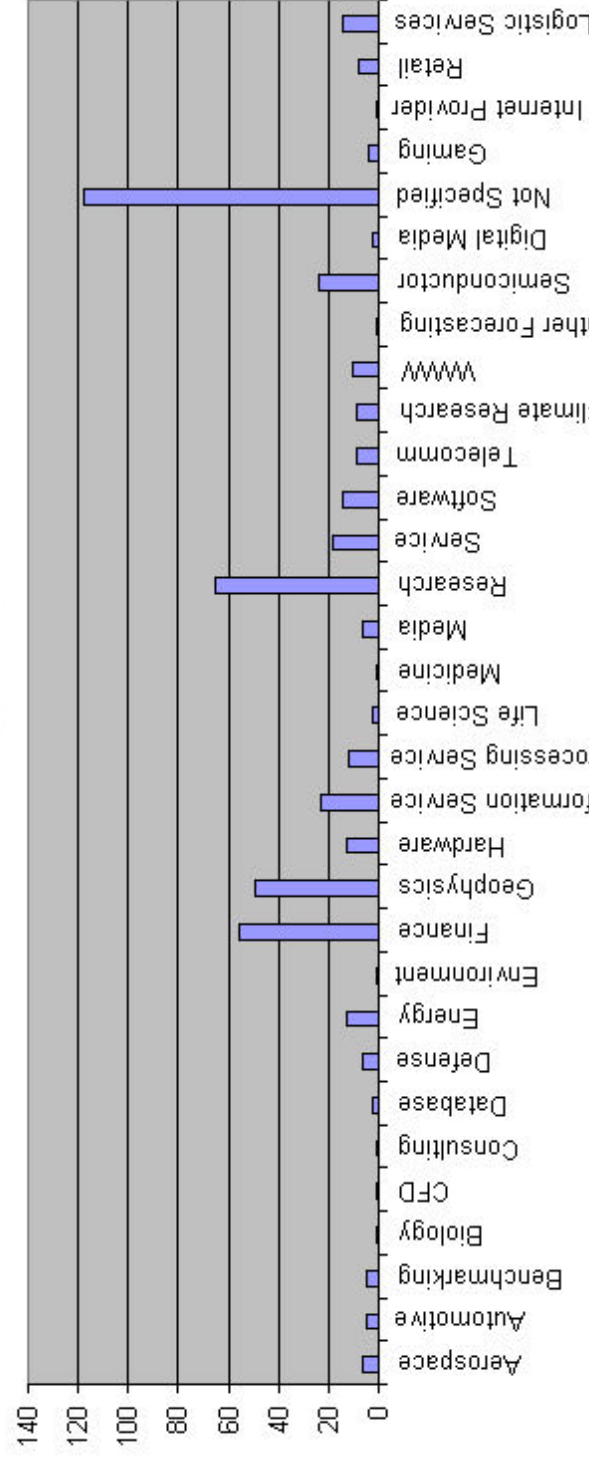

► The Future:

- During the past 20 years, the trends indicated by ever faster networks, distributed systems, and multi-processor computer architectures (even at the desktop level) clearly show that *parallelism is the future of computing*.

Concepts and Terminology

von Neumann Architecture

- Named after the Hungarian mathematician John von Neumann who first authored the general requirements for an electronic computer in his 1945 papers.
- Since then, virtually all computers have followed this basic design, which differed from earlier computers programmed through "hard wiring".

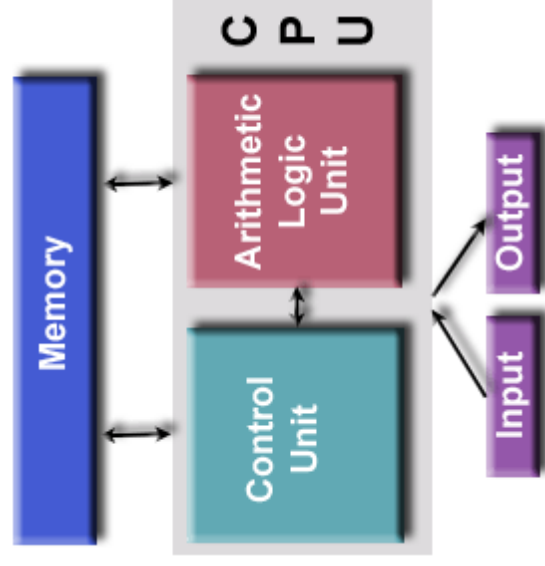

- Comprised of four main components:
 - Memory
 - Control Unit
 - Arithmetic Logic Unit
 - Input/Output
- Read/write, random access memory is used to store both program instructions and data
 - Program instructions are coded data which tell the computer to do something
 - Data is simply information to be used by the program
- Control unit fetches instructions/data from memory, decodes the instructions and then *sequentially* coordinates operations to accomplish the programmed task.
- Arithmetic Unit performs basic arithmetic operations
- Input/Output is the interface to the human operator

Concepts and Terminology

Flynn's Classical Taxonomy

- There are different ways to classify parallel computers. One of the more widely used classifications, in use since 1966, is called Flynn's Taxonomy.

- Flynn's taxonomy distinguishes multi-processor computer architectures according to how they can be classified along the two independent dimensions of **Instruction** and **Data**. Each of these dimensions can have only one of two possible states: **Single** or **Multiple**.
- The matrix below defines the 4 possible classifications according to Flynn:

S I S D Single Instruction, Single Data	S I M D Single Instruction, Multiple Data
M I S D Multiple Instruction, Single Data	M I M D Multiple Instruction, Multiple Data

▶ **Single Instruction, Single Data (SISD):**

- A serial (non-parallel) computer
- Single instruction: only one instruction stream is being acted on by the CPU during any one clock cycle
- Single data: only one data stream is being used as input during any one clock cycle
- Deterministic execution
- This is the oldest and even today, the most common type of computer
- Examples: older generation mainframes, minicomputers and workstations; most modern day PCs.

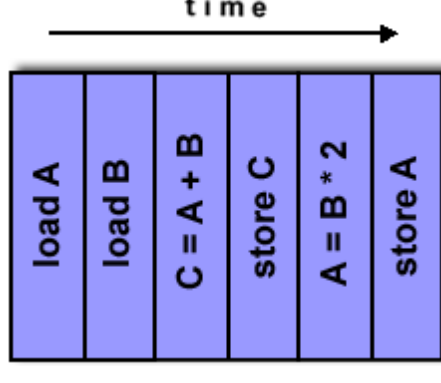

UNIVAC1

IBM 360

CRAY1



CDC 7600



PDP1



Dell Laptop



▶ Single Instruction, Multiple Data (SIMD):

- A type of parallel computer
- Single instruction: All processing units execute the same instruction at any given clock cycle
- Multiple data: Each processing unit can operate on a different data element
- Best suited for specialized problems characterized by a high degree of regularity, such as graphics/image processing.
- Synchronous (lockstep) and deterministic execution
- Two varieties: Processor Arrays and Vector Pipelines
- Examples:
 - Processor Arrays: Connection Machine CM-2, MasPar MP-1 & MP-2, ILLIAC IV
 - Vector Pipelines: IBM 9000, Cray X-MP, Y-MP & C90, Fujitsu VP, NEC SX-2, Hitachi S820, ETA10

- Most modern computers, particularly those with graphics processor units (GPUs) employ SIMD instructions and execution units.

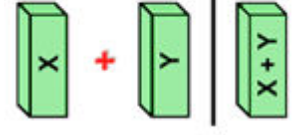
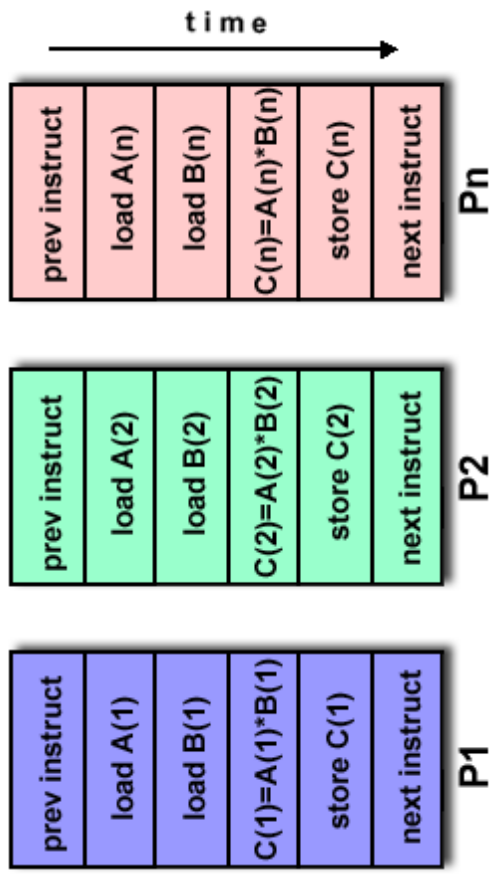

ILLIAC IV

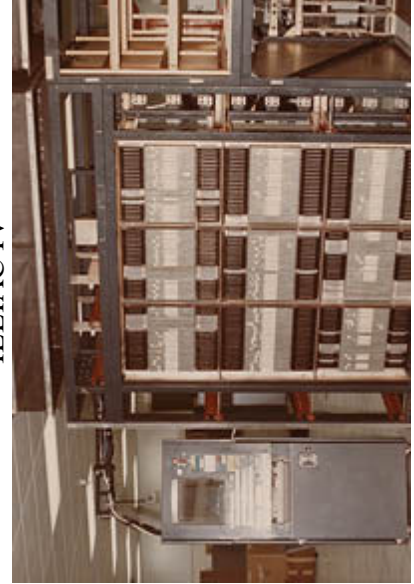

MasPar



Cray X-MP



Cray Y-MP



Thinking Machines CM-2

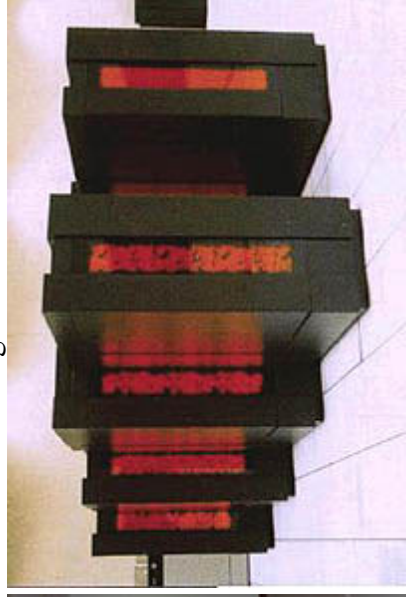

Cell Processor (GPU)

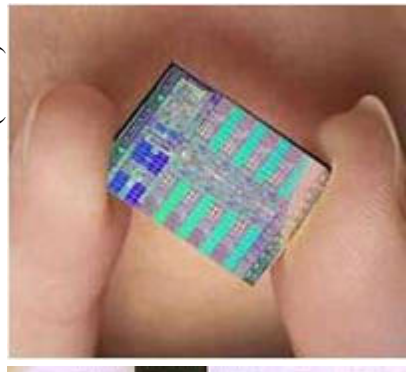

Multiple Instruction, Single Data (MISD):

- A single data stream is fed into multiple processing units.
- Each processing unit operates on the data independently via independent instruction streams.
- Few actual examples of this class of parallel computer have ever existed. One is the experimental Carnegie-Mellon C.mmp computer (1971).
- Some conceivable uses might be:
 - multiple frequency filters operating on a single signal stream
 - multiple cryptography algorithms attempting to crack a single coded message.

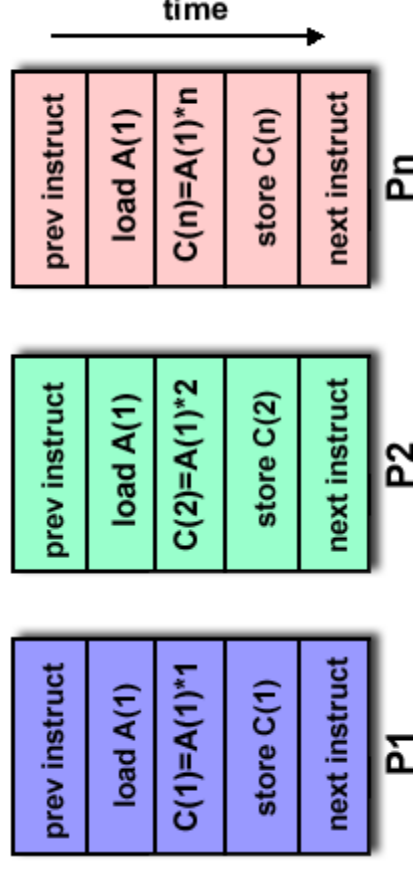

Multiple Instruction, Multiple Data (MIMD):

- Currently, the most common type of parallel computer. Most modern computers fall into this category.
- Multiple Instruction: every processor may be executing a different instruction stream
- Multiple Data: every processor may be working with a different data stream
- Execution can be synchronous or asynchronous, deterministic or non-deterministic
- Examples: most current supercomputers, networked parallel computer clusters and "grids", multi-processor SMP computers, multi-core PCs.
- Note: many MIMD architectures also include SIMD execution sub-components

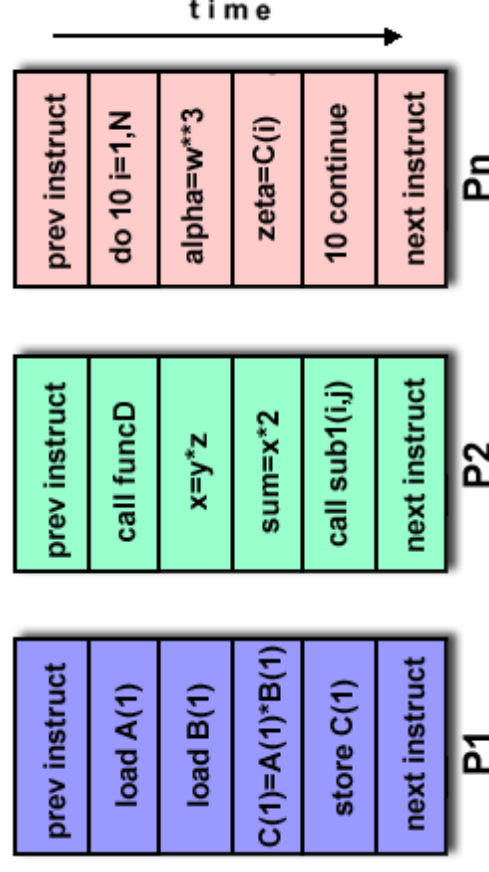

IBM POWER5

HP/Compaq Alphaserwer

Intel IA32



AMD Opteron



Cray XT3



IBM BG/L



Concepts and Terminology

Some General Parallel Terminology

Like everything else, parallel computing has its own "jargon". Some of the more commonly used terms associated with parallel computing are listed below. Most of these will be discussed in more detail later.

Task

A logically discrete section of computational work. A task is typically a program or program-like set of instructions that is executed by a processor.

Parallel Task

A task that can be executed by multiple processors safely (yields correct results)

Serial Execution

Execution of a program sequentially, one statement at a time. In the simplest sense, this is what happens on a one processor machine. However, virtually all parallel tasks will have sections of a parallel program that must be executed serially.

Parallel Execution

Execution of a program by more than one task, with each task being able to execute the same or different statement at the same moment in time.

Pipelining

Breaking a task into steps performed by different processor units, with inputs streaming through, much like an assembly line; a type of parallel computing.

Shared Memory

From a strictly hardware point of view, describes a computer architecture where all processors have direct (usually bus based) access to common physical memory. In a programming sense, it describes a model where parallel tasks all have the same "picture" of memory and can directly address and access the same logical memory locations regardless of where the physical memory actually exists.

Symmetric Multi-Processor (SMP)

Hardware architecture where multiple processors share a single address space and access to all resources; shared memory computing.

Distributed Memory

In hardware, refers to network based memory access for physical memory that is not common. As a programming model, tasks can only logically "see" local machine memory and must use communications to access memory on other machines where other tasks are executing.

Communications

Parallel tasks typically need to exchange data. There are several ways this can be accomplished, such as through a shared memory bus or over a network, however the actual event of data exchange is commonly referred to as communications regardless of the method employed.

Synchronization

The coordination of parallel tasks in real time, very often associated with communications. Often implemented by establishing a synchronization point within an application where a task may not proceed further until another task(s) reaches the same or logically equivalent point.

Synchronization usually involves waiting by at least one task, and can therefore cause a parallel application's wall clock execution time to increase.

Granularity

In parallel computing, granularity is a qualitative measure of the ratio of computation to communication.

- **Coarse:** relatively large amounts of computational work are done between communication events
- **Fine:** relatively small amounts of computational work are done between communication events

Observed Speedup

Observed speedup of a code which has been parallelized, defined as:

<p>wall-clock time of serial execution ----- wall-clock time of parallel execution</p>
--

One of the simplest and most widely used indicators for a parallel program's performance.

Parallel Overhead

The amount of time required to coordinate parallel tasks, as opposed to doing useful work. Parallel overhead can include factors such as:

- Task start-up time
- Synchronizations
- Data communications
- Software overhead imposed by parallel compilers, libraries, tools, operating system, etc.
- Task termination time

Massively Parallel

Refers to the hardware that comprises a given parallel system - having many processors. The meaning of "many" keeps increasing, but currently, the largest parallel computers can be comprised of processors numbering in the hundreds of thousands.

Embarrassingly Parallel

Solving many similar, but independent tasks simultaneously; little to no need for coordination between the tasks.

Scalability

Refers to a parallel system's (hardware and/or software) ability to demonstrate a proportionate increase in parallel speedup with the addition of more processors.

Factors that contribute to scalability include:

- Hardware - particularly memory-cpu bandwidths and network communications
- Application algorithm
- Parallel overhead related
- Characteristics of your specific application and coding

Multi-core Processors

Multiple processors (cores) on a single chip.

Cluster Computing

Use of a combination of commodity units (processors, networks or SMPs) to build a parallel system.

Supercomputing / High Performance Computing

Use of the world's fastest, largest machines to solve large problems.

Parallel Computer Memory Architectures

Shared Memory

► General Characteristics:

- Shared memory parallel computers vary widely, but generally have in common the ability for all processors to access all memory as global address space.
- Multiple processors can operate independently but share the same memory resources.
- Changes in a memory location effected by one processor are visible to all other processors.
- Shared memory machines can be divided into two main classes based upon memory access times: *UMA* and *NUMA*.

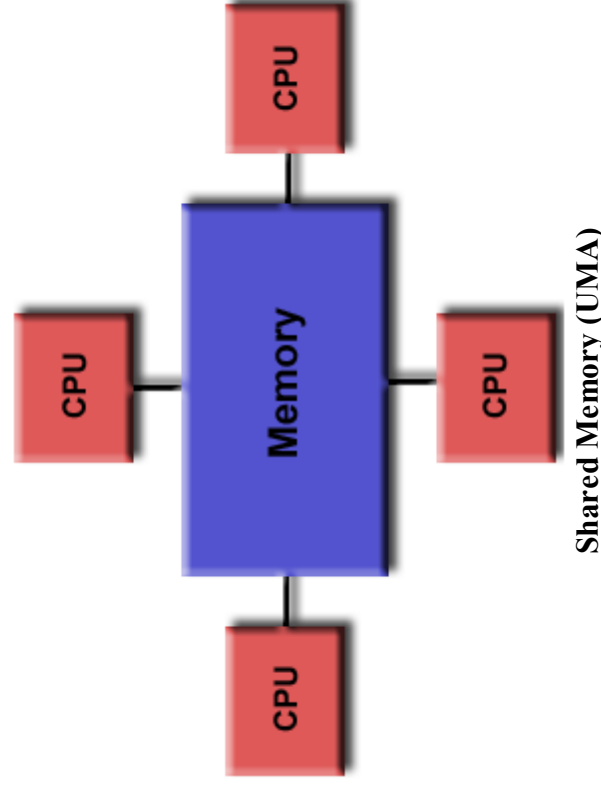

► Uniform Memory Access (UMA):

- Most commonly represented today by Symmetric Multiprocessor (SMP) machines
- Identical processors
- Equal access and access times to memory
- Sometimes called CC-UMA - Cache Coherent UMA. Cache coherent means if one processor updates a location in shared memory, all the other processors know about the update. Cache coherency is accomplished at the hardware level.

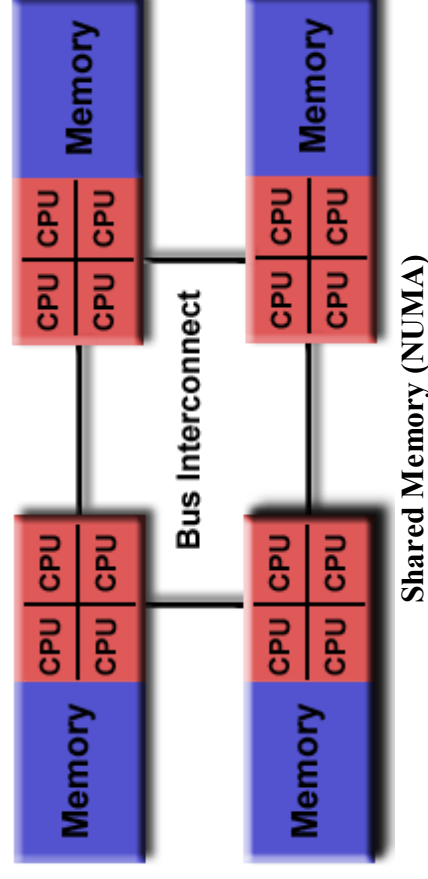

► Non-Uniform Memory Access (NUMA):

- Often made by physically linking two or more SMPs
- One SMP can directly access memory of another SMP
- Not all processors have equal access time to all memories
- Memory access across link is slower
- If cache coherency is maintained, then may also be called CC-NUMA - Cache Coherent NUMA

► Advantages:

- Global address space provides a user-friendly programming perspective to memory
- Data sharing between tasks is both fast and uniform due to the proximity of memory to CPUs

► Disadvantages:

- Primary disadvantage is the lack of scalability between memory and CPUs. Adding more CPUs can geometrically increase traffic on the shared memory-CPU path, and for cache coherent systems, geometrically increase traffic associated with cache/memory management.
- Programmer responsibility for synchronization constructs that insure "correct" access of global memory.
- Expense: it becomes increasingly difficult and expensive to design and produce shared memory machines with ever increasing numbers of processors.

Parallel Computer Memory Architectures

Distributed Memory

► General Characteristics:

- Like shared memory systems, distributed memory systems vary widely but share a common characteristic. Distributed memory systems require a communication network to connect inter-processor memory.

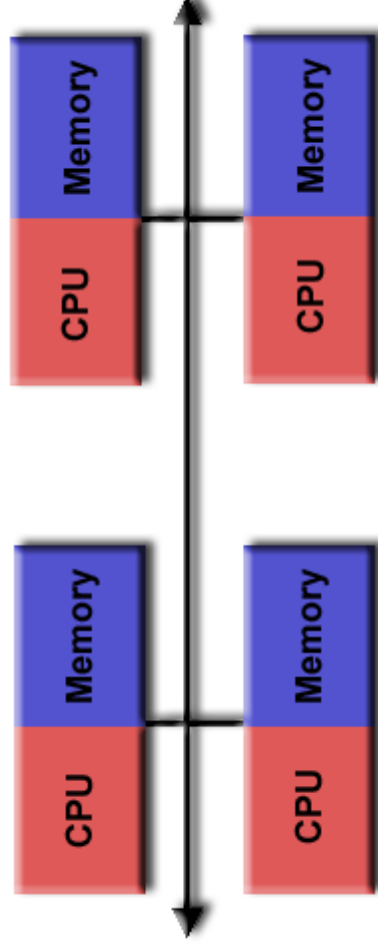

- Processors have their own local memory. Memory addresses in one processor do not map to another processor, so there is no concept of global address space across all processors.
- Because each processor has its own local memory, it operates independently. Changes it makes to its local memory have no effect on the memory of other processors. Hence, the concept of cache coherency does not apply.

- When a processor needs access to data in another processor, it is usually the task of the programmer to explicitly define how and when data is communicated. Synchronization between tasks is likewise the programmer's responsibility.
 - The network "fabric" used for data transfer varies widely, though it can be as simple as Ethernet.
- **Advantages:**
- Memory is scalable with number of processors. Increase the number of processors and the size of memory increases proportionately.
 - Each processor can rapidly access its own memory without interference and without the overhead incurred with trying to maintain cache coherency.
 - Cost effectiveness: can use commodity, off-the-shelf processors and networking.
- **Disadvantages:**
- The programmer is responsible for many of the details associated with data communication between processors.
 - It may be difficult to map existing data structures, based on global memory, to this memory organization.
 - Non-uniform memory access (NUMA) times

Parallel Computer Memory Architectures

Hybrid Distributed-Shared Memory

- The largest and fastest computers in the world today employ both shared and distributed memory architectures.

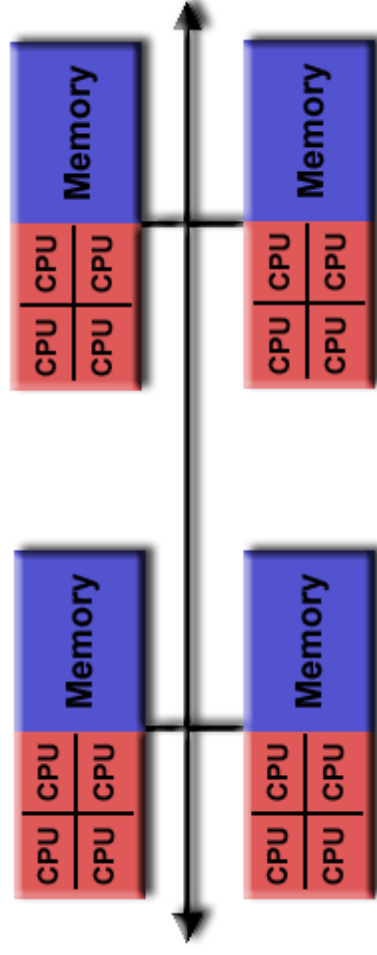

- The shared memory component is usually a cache coherent SMP machine. Processors on a given SMP can address that machine's memory as global.

- The distributed memory component is the networking of multiple SMPs. SMPs know only about their own memory - not the memory on another SMP. Therefore, network communications are required to move data from one SMP to another.
- Current trends seem to indicate that this type of memory architecture will continue to prevail and increase at the high end of computing for the foreseeable future.
- Advantages and Disadvantages: whatever is common to both shared and distributed memory architectures.

Parallel Programming Models

Overview

- There are several parallel programming models in common use:
 - Shared Memory
 - Threads
 - Message Passing
 - Data Parallel
 - Hybrid
- Parallel programming models exist as an abstraction above hardware and memory architectures.
- Although it might not seem apparent, these models are NOT specific to a particular type of machine or memory architecture. In fact, any of these models can (theoretically) be implemented on any underlying hardware. Two examples:

1. Shared memory model on a distributed memory machine: Kendall Square Research (KSR) ALLCACHE approach.

Machine memory was physically distributed, but appeared to the user as a single shared memory (global address space). Generically, this approach is referred to as "virtual shared memory". Note: although KSR is no longer in business, there is no reason to suggest that a similar implementation will not be made available by another vendor in the future.

2. Message passing model on a shared memory machine: MPI on SGI Origin.

The SGI Origin employed the CC-NUMA type of shared memory architecture, where every task has direct access to global memory. However, the ability to send and receive messages with MPI, as is commonly done over a network of distributed memory machines, is not only implemented but is very commonly used.

- Which model to use is often a combination of what is available and personal choice. There is no "best" model, although there certainly are better

implementations of some models over others.

- The following sections describe each of the models mentioned above, and also discuss some of their actual implementations.

Parallel Programming Models

Shared Memory Model

- In the shared-memory programming model, tasks share a common address space, which they read and write asynchronously.
- Various mechanisms such as locks / semaphores may be used to control access to the shared memory.
- An advantage of this model from the programmer's point of view is that the notion of data "ownership" is lacking, so there is no need to specify explicitly the communication of data between tasks. Program development can often be simplified.
- An important disadvantage in terms of performance is that it becomes more difficult to understand and manage data locality.
 - Keeping data local to the processor that works on it conserves memory accesses, cache refreshes and bus traffic that occurs when multiple processors use the same data.
 - Unfortunately, controlling data locality is hard to understand and beyond the control of the average user.

▶ Implementations:

- On shared memory platforms, the native compilers translate user program variables into actual memory addresses, which are global.
- No common distributed memory platform implementations currently exist. However, as mentioned previously in the Overview section, the KSR ALLCACHE approach provided a shared memory view of data even though the physical memory of the machine was distributed.

Parallel Programming Models

Threads Model

- In the threads model of parallel programming, a single process can have multiple, concurrent execution paths.
- Perhaps the most simple analogy that can be used to describe threads is the concept of a single program that includes a number of subroutines:

- The main program `a.out` is scheduled to run by the native operating system. `a.out` loads and acquires all of the necessary system and user resources to run.
 - `a.out` performs some serial work, and then creates a number of tasks (threads) that can be scheduled and run by the operating system concurrently.
 - Each thread has local data, but also, shares the entire resources of `a.out`. This saves the overhead associated with replicating a program's resources for each thread. Each thread also benefits from a global memory view because it shares the memory space of `a.out`.
 - A thread's work may best be described as a subroutine within the main program. Any thread can execute any subroutine at the same time as other threads.
 - Threads communicate with each other through global memory (updating address locations). This requires synchronization constructs to insure that more than one thread is not updating the same global address at any time.
 - Threads can come and go, but `a.out` remains present to provide the necessary shared resources until the application has completed.
- Threads are commonly associated with shared memory architectures and operating systems.

▲ Implementations:

- From a programming perspective, threads implementations commonly comprise:
 - A library of subroutines that are called from within parallel source code
 - A set of compiler directives imbedded in either serial or parallel source code

In both cases, the programmer is responsible for determining all parallelism.

- Threaded implementations are not new in computing. Historically, hardware vendors have implemented their own proprietary versions of threads. These implementations differed substantially from each other making it difficult for programmers to develop portable threaded applications.
- Unrelated standardization efforts have resulted in two very different implementations of threads: **POSIX Threads** and **OpenMP**.
- **POSIX Threads**
 - Library based; requires parallel coding
 - Specified by the IEEE POSIX 1003.1c standard (1995).
 - C Language only
 - Commonly referred to as Pthreads.
 - Most hardware vendors now offer Pthreads in addition to their proprietary threads implementations.
 - Very explicit parallelism; requires significant programmer attention to detail.

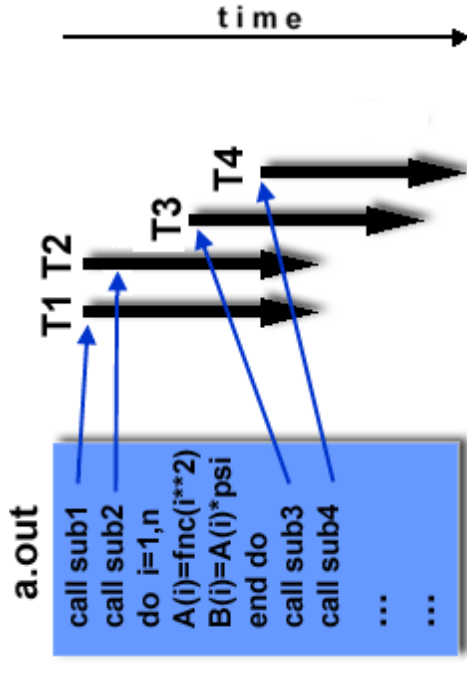

- **OpenMP**

- Compiler directive based; can use serial code
 - Jointly defined and endorsed by a group of major computer hardware and software vendors. The OpenMP Fortran API was released October 28, 1997. The C/C++ API was released in late 1998.
 - Portable / multi-platform, including Unix and Windows NT platforms
 - Available in C/C++ and Fortran implementations
 - Can be very easy and simple to use - provides for "incremental parallelism"
- Microsoft has its own implementation for threads, which is not related to the UNIX POSIX standard or OpenMP.

► **More Information:**

- POSIX Threads tutorial: computing.llnl.gov/tutorials/pthreads
- OpenMP tutorial: computing.llnl.gov/tutorials/openmp

Parallel Programming Models

Message Passing Model

- The message passing model demonstrates the following characteristics:
 - A set of tasks that use their own local memory during computation. Multiple tasks can reside on the same physical machine as well across an arbitrary number of machines.
 - Tasks exchange data through communications by sending and receiving messages.
 - Data transfer usually requires cooperative operations to be performed by each process. For example, a send operation must have a matching receive operation.

► **Implementations:**

- From a programming perspective, message passing implementations commonly comprise a library of subroutines that are embedded in source code. The programmer is responsible for determining all parallelism.

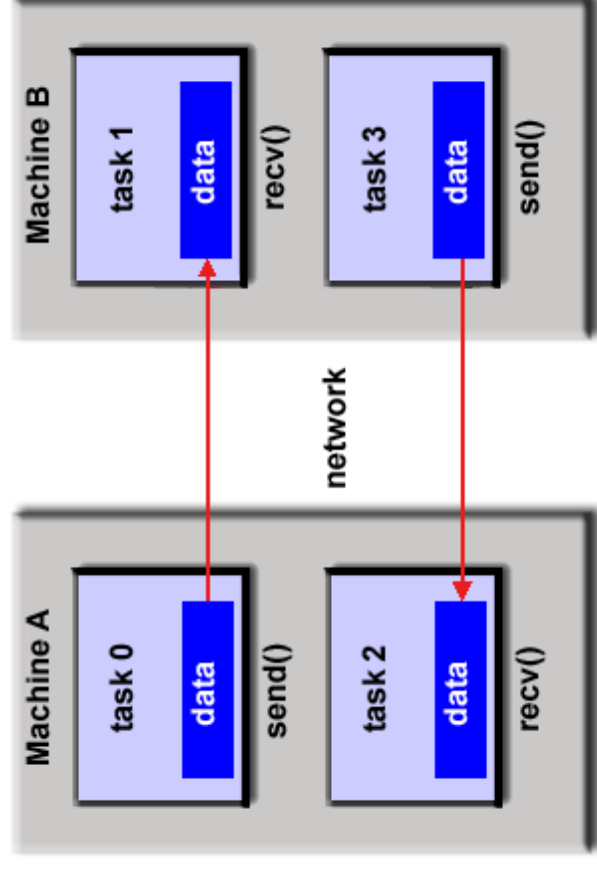

- Historically, a variety of message passing libraries have been available since the 1980s. These implementations differed substantially from each other making it difficult for programmers to develop portable applications.
- In 1992, the MPI Forum was formed with the primary goal of establishing a standard interface for message passing implementations.
- Part 1 of the **Message Passing Interface (MPI)** was released in 1994. Part 2 (MPI-2) was released in 1996. Both MPI specifications are available on the web at <http://www-unix.mcs.anl.gov/mpi/>.
- MPI is now the "de facto" industry standard for message passing, replacing virtually all other message passing implementations used for production work. Most, if not all of the popular parallel computing platforms offer at least one implementation of MPI. A few offer a full implementation of MPI-2.
- For shared memory architectures, MPI implementations usually don't use a network for task communications. Instead, they use shared memory (memory copies) for performance reasons.

► More Information:

- MPI tutorial: computing.llnl.gov/tutorials/mpi

Parallel Programming Models

Data Parallel Model

- The data parallel model demonstrates the following characteristics:
 - Most of the parallel work focuses on performing operations on a data set. The data set is typically organized into a common structure, such as an array or cube.
 - A set of tasks work collectively on the same data structure, however, each task works on a different partition of the same data structure.
 - Tasks perform the same operation on their partition of work, for example, "add 4 to every array element".
- On shared memory architectures, all tasks may have access to the data structure through global memory. On distributed memory architectures the data structure is split up and resides as "chunks" in the local memory of each task.

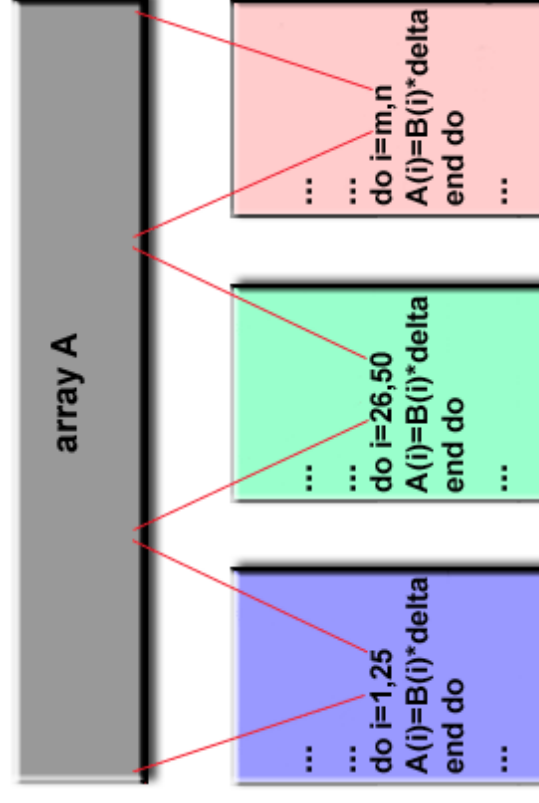

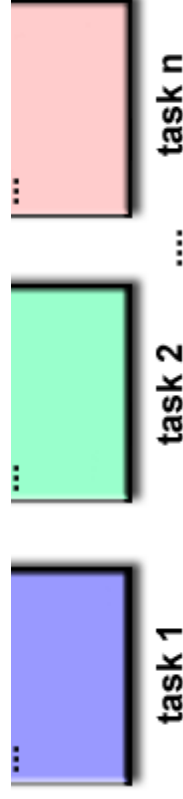

► Implementations:

- Programming with the data parallel model is usually accomplished by writing a program with data parallel constructs. The constructs can be calls to a data parallel subroutine library or, compiler directives recognized by a data parallel compiler.
- **Fortran 90 and 95 (F90, F95):** ISO/ANSI standard extensions to Fortran 77.
 - Contains everything that is in Fortran 77
 - New source code format; additions to character set
 - Additions to program structure and commands
 - Variable additions - methods and arguments
 - Pointers and dynamic memory allocation added
 - Array processing (arrays treated as objects) added
 - Recursive and new intrinsic functions added
 - Many other new features

Implementations are available for most common parallel platforms.

- **High Performance Fortran (HPF):** Extensions to Fortran 90 to support data parallel programming.
 - Contains everything in Fortran 90
 - Directives to tell compiler how to distribute data added
 - Assertions that can improve optimization of generated code added
 - Data parallel constructs added (now part of Fortran 95)

Implementations are available for most common parallel platforms.

- **Compiler Directives:** Allow the programmer to specify the distribution and alignment of data. Fortran implementations are available for most common parallel platforms.
- Distributed memory implementations of this model usually have the compiler convert the program into standard code with calls to a message passing library (MPI usually) to distribute the data to all the processes. All message passing is done invisibly to the programmer.

Parallel Programming Models

Other Models

- Other parallel programming models besides those previously mentioned certainly exist, and will continue to evolve along with the ever changing world of computer hardware and software. Only three of the more common ones are mentioned here.

► **Hybrid:**

- In this model, any two or more parallel programming models are combined.
- Currently, a common example of a hybrid model is the combination of the message passing model (MPI) with either the threads model (POSIX threads) or the shared memory model (OpenMP). This hybrid model lends itself well to the increasingly common hardware environment of networked SMP machines.
- Another common example of a hybrid model is combining data parallel with message passing. As mentioned in the data parallel model section previously, data parallel implementations (F90, HPF) on distributed memory architectures actually use message passing to transmit data between tasks, transparently to the programmer.

► **Single Program Multiple Data (SPMD):**

- SPMD is actually a "high level" programming model that can be built upon any combination of the previously mentioned parallel programming models.
- A single program is executed by all tasks simultaneously.
- At any moment in time, tasks can be executing the same or different instructions within the same program.
- SPMD programs usually have the necessary logic programmed into them to allow different tasks to branch or conditionally execute only those parts of the program they are designed to execute. That is, tasks do not necessarily have to execute the entire program - perhaps only a portion of it.

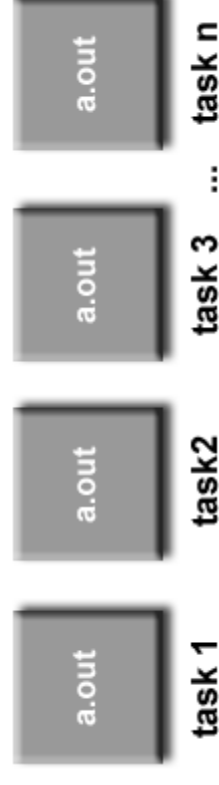

- All tasks may use different data

► **Multiple Program Multiple Data (MPMD):**

- Like SPMD, MPMD is actually a "high level" programming model that can be built upon any combination of the previously mentioned parallel programming models.
- MPMD applications typically have multiple executable object files (programs). While the application is being run in parallel, each task can be executing the same or different program as other tasks.

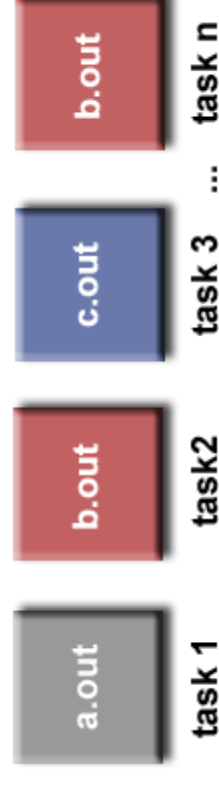

- All tasks may use different data

Designing Parallel Programs

Automatic vs. Manual Parallelization

- Designing and developing parallel programs has characteristically been a very manual process. The programmer is typically responsible for both identifying and actually implementing parallelism.
- Very often, manually developing parallel codes is a time consuming, complex, error-prone and *iterative* process.
- For a number of years now, various tools have been available to assist the programmer with converting serial programs into parallel programs. The most common type of tool used to automatically parallelize a serial program is a parallelizing compiler or pre-processor.
- A parallelizing compiler generally works in two different ways:
 - Fully Automatic
 - The compiler analyzes the source code and identifies opportunities for parallelism.
 - The analysis includes identifying inhibitors to parallelism and possibly a cost weighting on whether or not the parallelism would actually improve performance.
 - Loops (do, for) loops are the most frequent target for automatic parallelization.
 - Programmer Directed
 - Using "compiler directives" or possibly compiler flags, the programmer explicitly tells the compiler how to parallelize the code.
 - May be able to be used in conjunction with some degree of automatic parallelization also.
- If you are beginning with an existing serial code and have time or budget constraints, then automatic parallelization may be the answer. However, there are several important caveats that apply to automatic parallelization:
 - Wrong results may be produced
 - Performance may actually degrade
 - Much less flexible than manual parallelization
 - Limited to a subset (mostly loops) of code
 - May actually not parallelize code if the analysis suggests there are inhibitors or the code is too complex
- The remainder of this section applies to the manual method of developing parallel codes.

Designing Parallel Programs

Understand the Problem and the Program

- Undoubtedly, the first step in developing parallel software is to first understand the problem that you wish to solve in parallel. If you are starting with a serial program, this necessitates understanding the existing code also.
- Before spending time in an attempt to develop a parallel solution for a problem, determine whether or not the problem is one that can actually be parallelized.
 - Example of Parallelizable Problem:

Calculate the potential energy for each of several thousand independent conformations of a molecule. When done, find the minimum energy conformation.

This problem is able to be solved in parallel. Each of the molecular conformations is independently determinable. The calculation of the minimum energy conformation is also a parallelizable problem.

- Example of a Non-parallelizable Problem:

Calculation of the Fibonacci series (1,1,2,3,5,8,13,21,...) by use of the formula:

$$F(k + 2) = F(k + 1) + F(k)$$

This is a non-parallelizable problem because the calculation of the Fibonacci sequence as shown would entail dependent calculations rather than independent ones. The calculation of the $k + 2$ value uses those of both $k + 1$ and k . These three terms cannot be calculated independently and therefore, not in parallel.

- Identify the program's *hotspots*:
 - Know where most of the real work is being done. The majority of scientific and technical programs usually accomplish most of their work in a few places.
 - Profilers and performance analysis tools can help here
 - Focus on parallelizing the hotspots and ignore those sections of the program that account for little CPU usage.
- Identify *bottlenecks* in the program
 - Are there areas that are disproportionately slow, or cause parallelizable work to halt or be deferred? For example, I/O is usually something that slows a program down.
 - May be possible to restructure the program or use a different algorithm to reduce or eliminate unnecessary slow areas

- Identify inhibitors to parallelism. One common class of inhibitor is *data dependence*, as demonstrated by the Fibonacci sequence above.
- Investigate other algorithms if possible. This may be the single most important consideration when designing a parallel application.

Designing Parallel Programs

Partitioning

- One of the first steps in designing a parallel program is to break the problem into discrete "chunks" of work that can be distributed to multiple tasks. This is known as decomposition or partitioning.

- There are two basic ways to partition computational work among parallel tasks: *domain decomposition* and *functional decomposition*.

► Domain Decomposition:

- In this type of partitioning, the data associated with a problem is decomposed. Each parallel task then works on a portion of the data.

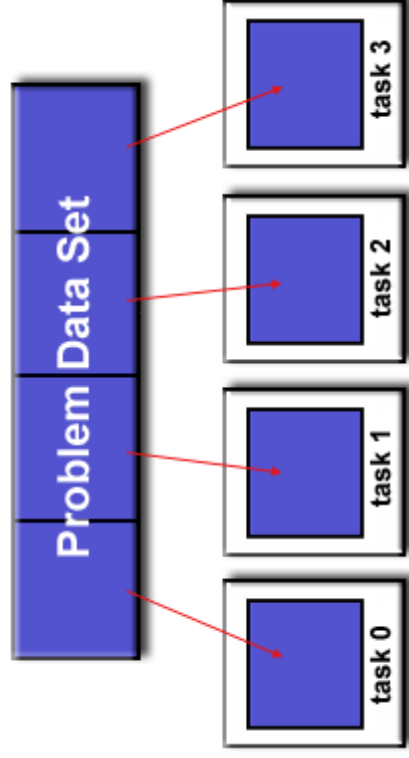

- There are different ways to partition data:

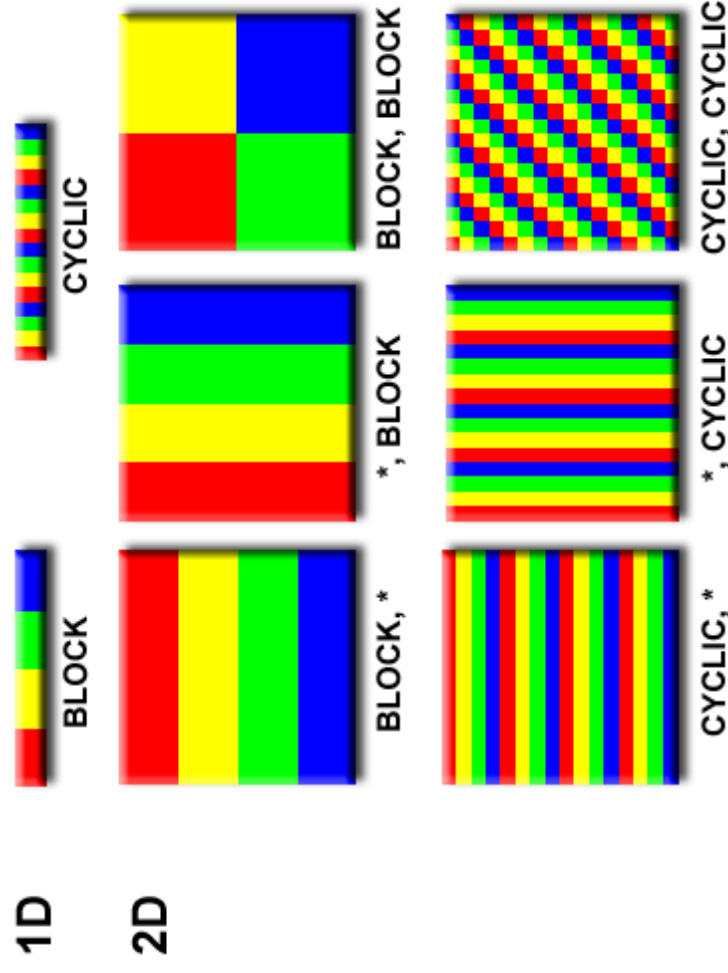

► Functional Decomposition:

- In this approach, the focus is on the computation that is to be performed rather than on the data manipulated by the computation. The problem is decomposed according to the work that must be done. Each task then performs a portion of the overall work.

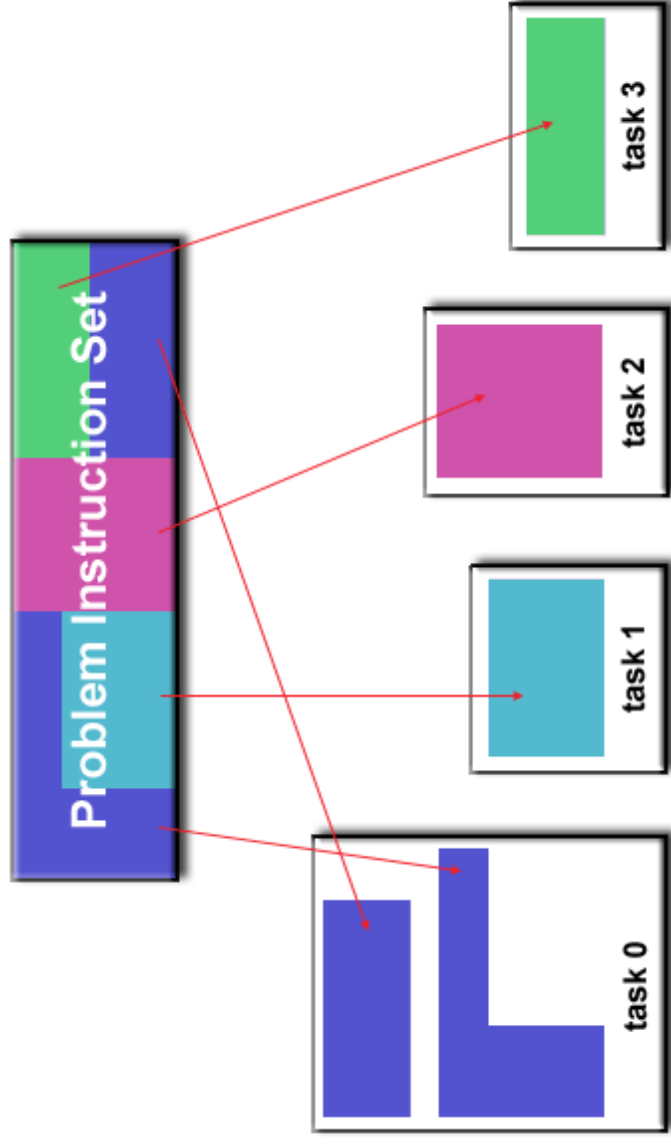

- Functional decomposition lends itself well to problems that can be split into different tasks. For example:

Ecosystem Modeling

Each program calculates the population of a given group, where each group's growth depends on that of its neighbors. As time progresses, each process calculates its current state, then exchanges information with the neighbor populations. All tasks then progress to calculate the state at the next time step.

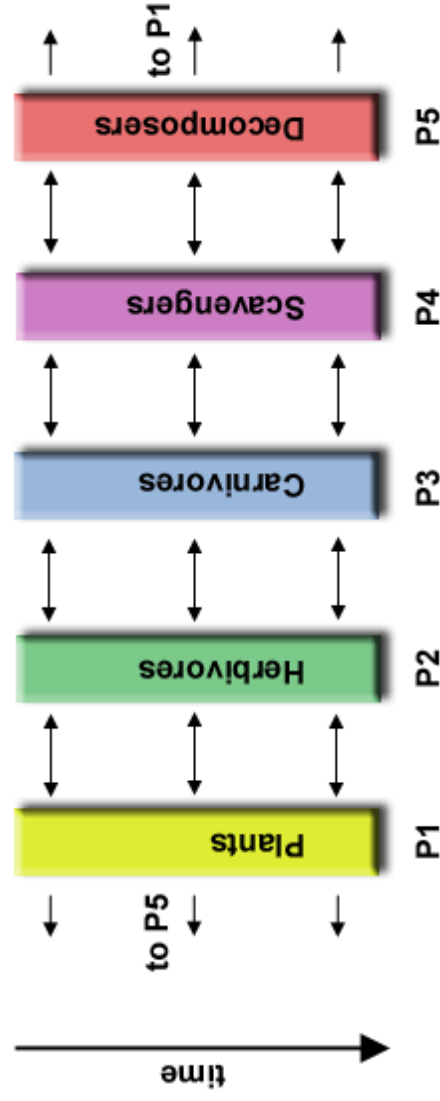

Signal Processing

An audio signal data set is passed through four distinct computational filters. Each filter is a separate process. The first segment of data must pass through the first filter before progressing to the second. When it does, the second segment of data passes through the first filter. By the time the fourth segment of data is in the first filter, all four tasks are busy.

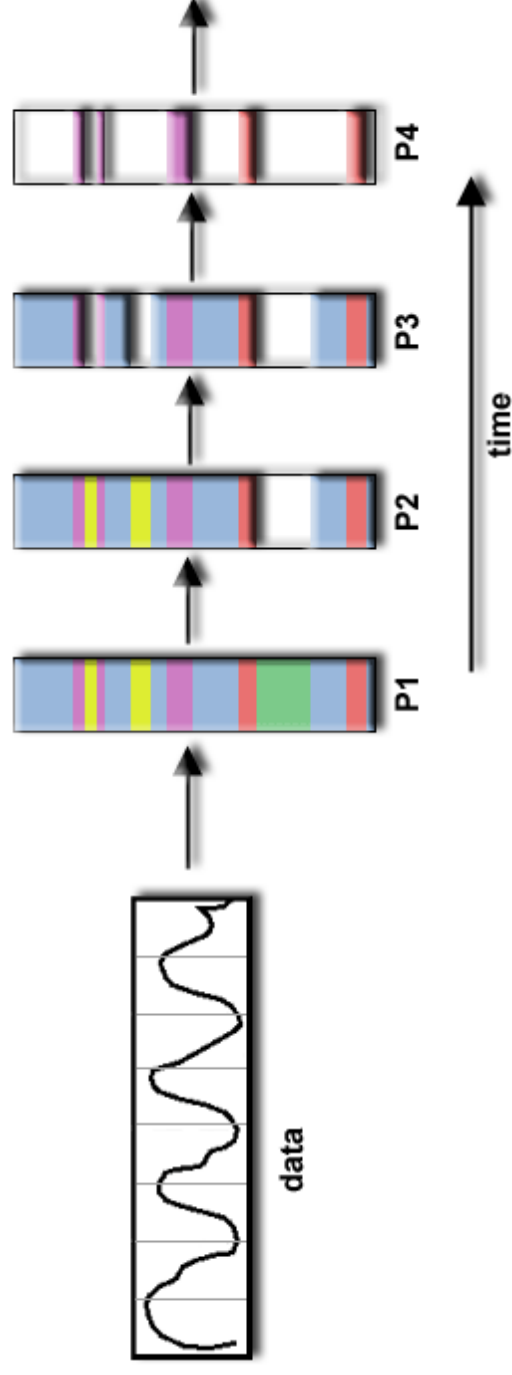

Climate Modeling

Each model component can be thought of as a separate task. Arrows represent exchanges of data between components during computation: the atmosphere model generates wind velocity data that are used by the ocean model, the ocean model generates sea surface temperature data that are used by the atmosphere model, and so on.

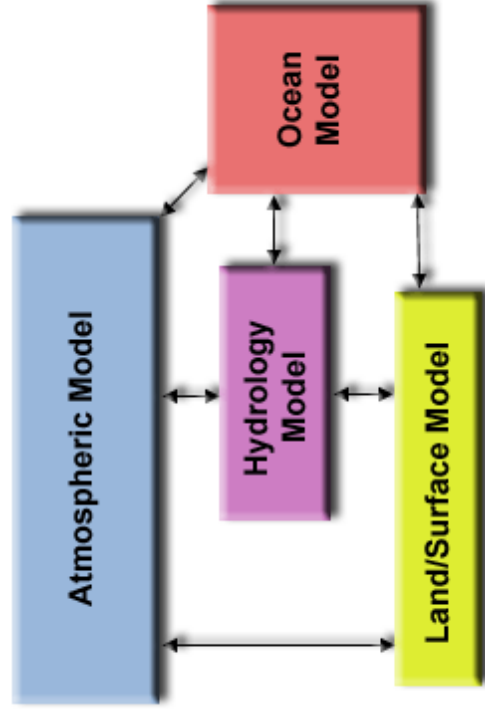

- Combining these two types of problem decomposition is common and natural.

Designing Parallel Programs

Communications

▶ Who Needs Communications?

The need for communications between tasks depends upon your problem:

- **You DON'T need communications**
 - Some types of problems can be decomposed and executed in parallel with virtually no need for tasks to share data. For example, imagine an image processing operation where every pixel in a black and white image needs to have its color reversed. The image data can easily be distributed to multiple tasks that then act independently of each other to do their portion of the work.
 - These types of problems are often called *embarrassingly parallel* because they are so straight-forward. Very little inter-task communication is required.
- **You DO need communications**
 - Most parallel applications are not quite so simple, and do require tasks to share data with each other. For example, a 3-D heat diffusion problem requires a task to know the temperatures calculated by the tasks that have neighboring data. Changes to neighboring data has a direct effect on that task's data.

▶ Factors to Consider:

There are a number of important factors to consider when designing your program's inter-task communications:

- **Cost of communications**
 - Inter-task communication virtually always implies overhead.
 - Machine cycles and resources that could be used for computation are instead used to package and transmit data.
 - Communications frequently require some type of synchronization between tasks, which can result in tasks spending time "waiting" instead of doing work.
 - Competing communication traffic can saturate the available network bandwidth, further aggravating performance problems.
- **Latency vs. Bandwidth**
 - *latency* is the time it takes to send a minimal (0 byte) message from point A to point B. Commonly expressed as microseconds.
 - *bandwidth* is the amount of data that can be communicated per unit of time. Commonly expressed as megabytes/sec or gigabytes/sec.
 - Sending many small messages can cause latency to dominate communication overheads. Often it is more efficient to package small messages into a larger message, thus increasing the effective communications bandwidth.
- **Visibility of communications**

- With the Message Passing Model, communications are explicit and generally quite visible and under the control of the programmer.
 - With the Data Parallel Model, communications often occur transparently to the programmer, particularly on distributed memory architectures. The programmer may not even be able to know exactly how inter-task communications are being accomplished.
- **Synchronous vs. asynchronous communications**
 - Synchronous communications require some type of "handshaking" between tasks that are sharing data. This can be explicitly structured in code by the programmer, or it may happen at a lower level unknown to the programmer.
 - Synchronous communications are often referred to as **blocking** communications since other work must wait until the communications have completed.
 - Asynchronous communications allow tasks to transfer data independently from one another. For example, task 1 can prepare and send a message to task 2, and then immediately begin doing other work. When task 2 actually receives the data doesn't matter.
 - Asynchronous communications are often referred to as **non-blocking** communications since other work can be done while the communications are taking place.
 - Interleaving computation with communication is the single greatest benefit for using asynchronous communications.
 - **Scope of communications**
 - Knowing which tasks must communicate with each other is critical during the design stage of a parallel code. Both of the two scoping described below can be implemented synchronously or asynchronously.
 - **Point-to-point** - involves two tasks with one task acting as the sender/producer of data, and the other acting as the receiver/consumer.
 - **Collective** - involves data sharing between more than two tasks, which are often specified as being members in a common group, or collective. Some common variations (there are more):

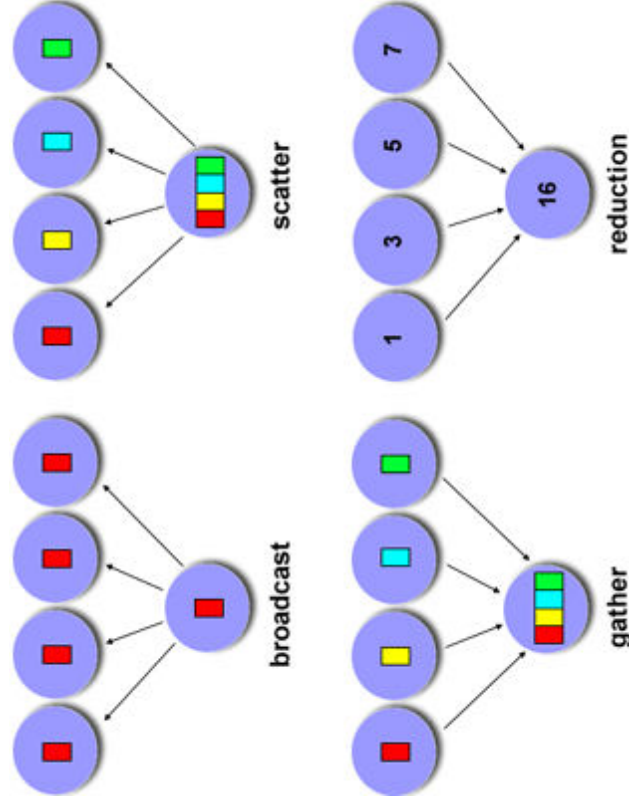

- **Efficiency of communications**
 - Very often, the programmer will have a choice with regard to factors that can affect communications performance. Only a few are mentioned here.
 - Which implementation for a given model should be used? Using the Message Passing Model as an example, one MPI implementation may be faster on a given hardware platform than another.
 - What type of communication operations should be used? As mentioned previously, asynchronous communication operations can improve overall program performance.
 - Network media - some platforms may offer more than one network for communications. Which one is best?
- **Overhead and Complexity**

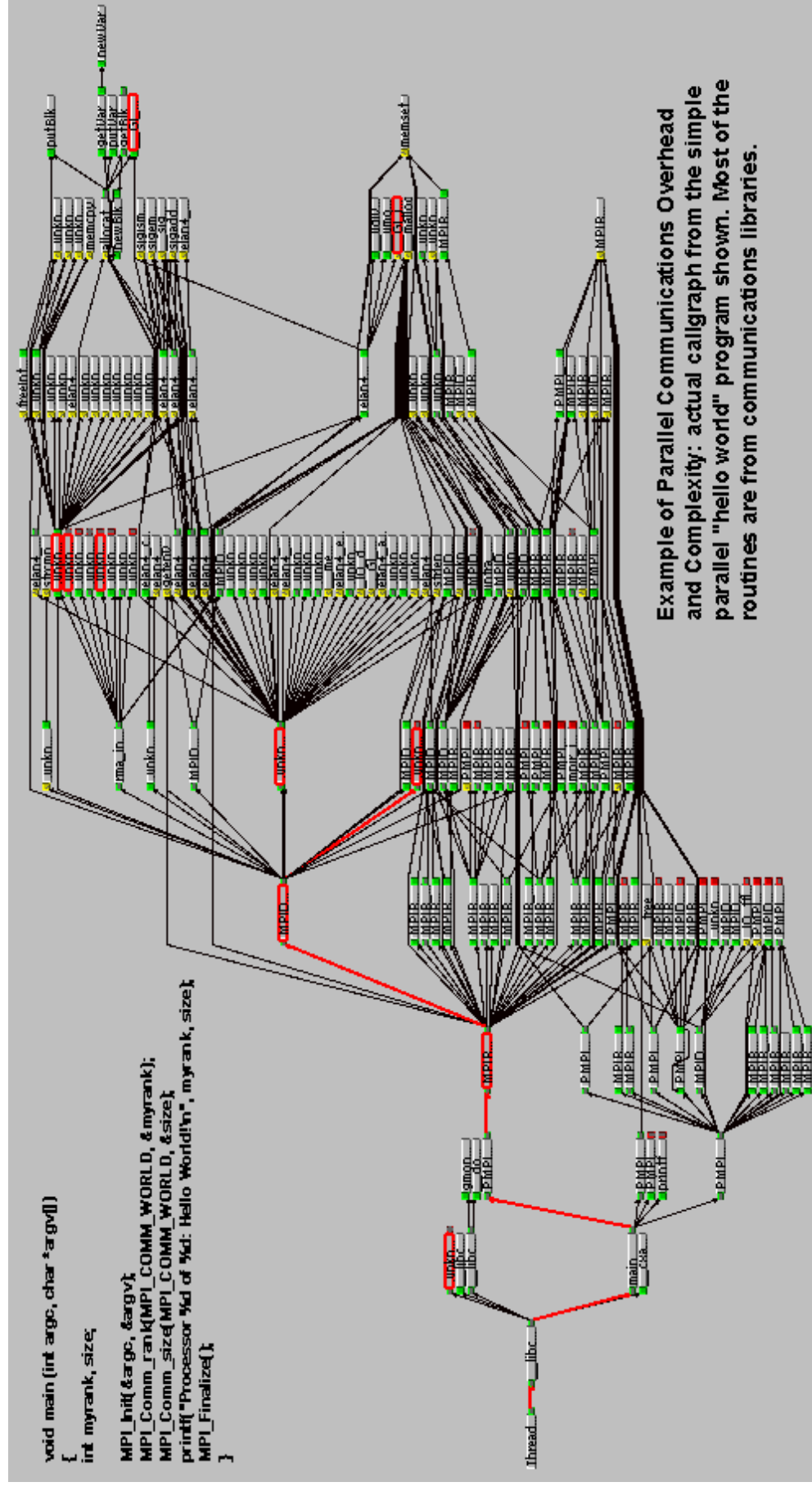

- Finally, realize that this is only a partial list of things to consider!!

Designing Parallel Programs

Synchronization

► Types of Synchronization:

- **Barrier**
 - Usually implies that all tasks are involved
 - Each task performs its work until it reaches the barrier. It then stops, or "blocks".
 - When the last task reaches the barrier, all tasks are synchronized.
 - What happens from here varies. Often, a serial section of work must be done. In other cases, the tasks are automatically released to continue their work.
- **Lock / semaphore**
 - Can involve any number of tasks
 - Typically used to serialize (protect) access to global data or a section of code. Only one task at a time may use (own) the lock / semaphore / flag.
 - The first task to acquire the lock "sets" it. This task can then safely (serially) access the protected data or code.
 - Other tasks can attempt to acquire the lock but must wait until the task that owns the lock releases it.
 - Can be blocking or non-blocking
- **Synchronous communication operations**
 - Involves only those tasks executing a communication operation
 - When a task performs a communication operation, some form of coordination is required with the other task(s) participating in the communication. For example, before a task can perform a send operation, it must first receive an acknowledgment from the receiving task that it is OK to send.
 - Discussed previously in the Communications section.

Designing Parallel Programs

Data Dependencies

► Definition:

- A *dependence* exists between program statements when the order of statement execution affects the results of the program.
- A *data dependence* results from multiple use of the same location(s) in storage by different tasks.

- Dependencies are important to parallel programming because they are one of the primary inhibitors to parallelism.

► Examples:

- Loop carried data dependence

```
DO 500 J = MYSTART,MYEND
  A(J) = A(J-1) * 2.0
500 CONTINUE
```

The value of $A(J-1)$ must be computed before the value of $A(J)$, therefore $A(J)$ exhibits a data dependency on $A(J-1)$. Parallelism is inhibited.

If Task 2 has $A(J)$ and task 1 has $A(J-1)$, computing the correct value of $A(J)$ necessitates:

- Distributed memory architecture - task 2 must obtain the value of $A(J-1)$ from task 1 after task 1 finishes its computation
- Shared memory architecture - task 2 must read $A(J-1)$ after task 1 updates it

- Loop independent data dependence

```
task 1      task 2
-----
X = 2      X = 4
.          .
.          .
Y = X**2   Y = X**3
```

As with the previous example, parallelism is inhibited. The value of Y is dependent on:

- Distributed memory architecture - if or when the value of X is communicated between the tasks.
- Shared memory architecture - which task last stores the value of X .

- Although all data dependencies are important to identify when designing parallel programs, loop carried dependencies are particularly important since loops are possibly the most common target of parallelization efforts.

► How to Handle Data Dependencies:

- Distributed memory architectures - communicate required data at synchronization points.
- Shared memory architectures -synchronize read/write operations between tasks.

Designing Parallel Programs

Load Balancing

- Load balancing refers to the practice of distributing work among tasks so that **all** tasks are kept busy **all** of the time. It can be considered a minimization of task idle time.
- Load balancing is important to parallel programs for performance reasons. For example, if all tasks are subject to a barrier synchronization point, the slowest task will determine the overall performance.

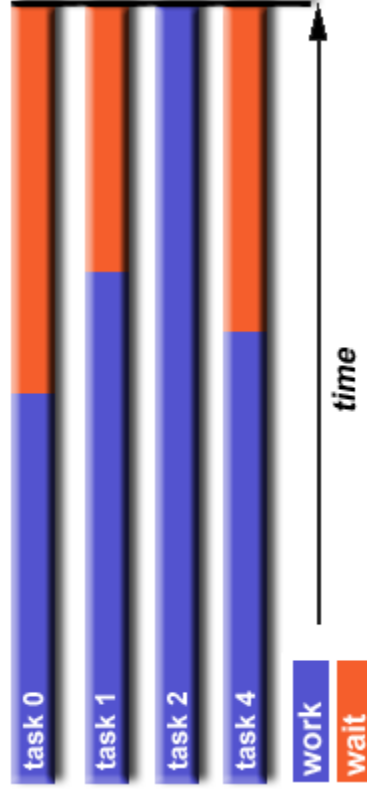

How to Achieve Load Balance:

- **Equally partition the work each task receives**
 - For array/matrix operations where each task performs similar work, evenly distribute the data set among the tasks.
 - For loop iterations where the work done in each iteration is similar, evenly distribute the iterations across the tasks.
 - If a heterogeneous mix of machines with varying performance characteristics are being used, be sure to use some type of performance analysis tool to detect any load imbalances. Adjust work accordingly.
- **Use dynamic work assignment**
 - Certain classes of problems result in load imbalances even if data is evenly distributed among tasks:
 - Sparse arrays - some tasks will have actual data to work on while others have mostly "zeros".

- Adaptive grid methods - some tasks may need to refine their mesh while others don't.
- N -body simulations - where some particles may migrate to/from their original task domain to another task's; where the particles owned by some tasks require more work than those owned by other tasks.
- When the amount of work each task will perform is intentionally variable, or is unable to be predicted, it may be helpful to use a *scheduler - task pool* approach. As each task finishes its work, it queues to get a new piece of work.
- It may become necessary to design an algorithm which detects and handles load imbalances as they occur dynamically within the code.

Designing Parallel Programs

Granularity

▲ Computation / Communication Ratio:

- In parallel computing, granularity is a qualitative measure of the ratio of computation to communication.
- Periods of computation are typically separated from periods of communication by synchronization events.

► Fine-grain Parallelism:

- Relatively small amounts of computational work are done between communication events
- Low computation to communication ratio
- Facilitates load balancing
- Implies high communication overhead and less opportunity for performance enhancement
- If granularity is too fine it is possible that the overhead required for communications and synchronization between tasks takes longer than the computation.

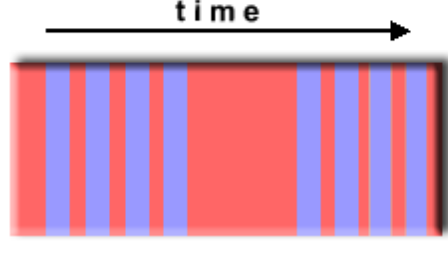

► Coarse-grain Parallelism:

- Relatively large amounts of computational work are done between communication/synchronization events
- High computation to communication ratio
- Implies more opportunity for performance increase
- Harder to load balance efficiently

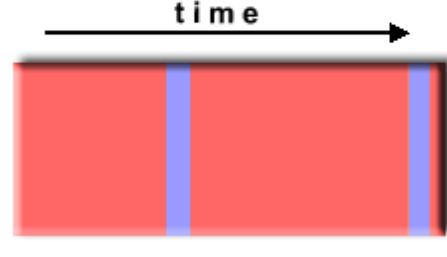

communication
computation

► Which is Best?

- The most efficient granularity is dependent on the algorithm and the hardware environment in which it runs.
- In most cases the overhead associated with communications and synchronization is high relative to execution speed so it is advantageous to have coarse granularity.
- Fine-grain parallelism can help reduce overheads due to load imbalance.

Designing Parallel Programs

I/O

► The Bad News:

- I/O operations are generally regarded as inhibitors to parallelism
- Parallel I/O systems may be immature or not available for all platforms
- In an environment where all tasks see the same file space, write operations can result in file overwriting
- Read operations can be affected by the file server's ability to handle multiple read requests at the same time
- I/O that must be conducted over the network (NFS, non-local) can cause severe bottlenecks and even crash file servers.

▲ **The Good News:**

- Parallel file systems are available. For example:
 - GPFS: General Parallel File System for AIX (IBM)
 - Lustre: for Linux clusters (SUN Microsystems)
 - PVFS/PVFS2: Parallel Virtual File System for Linux clusters (Clemson/Argonne/Ohio State/others)
 - PanFS: Panasas ActiveScale File System for Linux clusters (Panasas, Inc.)
 - HP SFS: HP StorageWorks Scalable File Share. Lustre based parallel file system (Global File System for Linux) product from HP
- The parallel I/O programming interface specification for MPI has been available since 1996 as part of MPI-2. Vendor and "free" implementations are now commonly available.
- Some options:
 - If you have access to a parallel file system, investigate using it. If you don't, keep reading...
 - Rule #1: Reduce overall I/O as much as possible
 - Confine I/O to specific serial portions of the job, and then use parallel communications to distribute data to parallel tasks. For example, Task 1 could read an input file and then communicate required data to other tasks. Likewise, Task 1 could perform write operation after receiving required data from all other tasks.
 - For distributed memory systems with shared filesystem, perform I/O in local, non-shared filesystem. For example, each processor may have /tmp filesystem which can be used. This is usually much more efficient than performing I/O over the network to one's home directory.
 - Create unique filenames for each task's input/output file(s)

Designing Parallel Programs

Limits and Costs of Parallel Programming

▲ Amdahl's Law:

- **Amdahl's Law** states that potential program speedup is defined by the fraction of code (P) that can be parallelized:

$$\text{speedup} = \frac{1}{1 - P}$$

- If none of the code can be parallelized, $P = 0$ and the speedup = 1 (no speedup).
- If all of the code is parallelized, $P = 1$ and the speedup is infinite (in theory).
- If 50% of the code can be parallelized, maximum speedup = 2, meaning the code will run twice as fast.
- Introducing the number of processors performing the parallel fraction of work, the relationship can be modeled by:

$$\text{speedup} = \frac{1}{\frac{P}{N} + S}$$

where P = parallel fraction, N = number of processors and S = serial fraction.

- It soon becomes obvious that there are limits to the scalability of parallelism. For example:

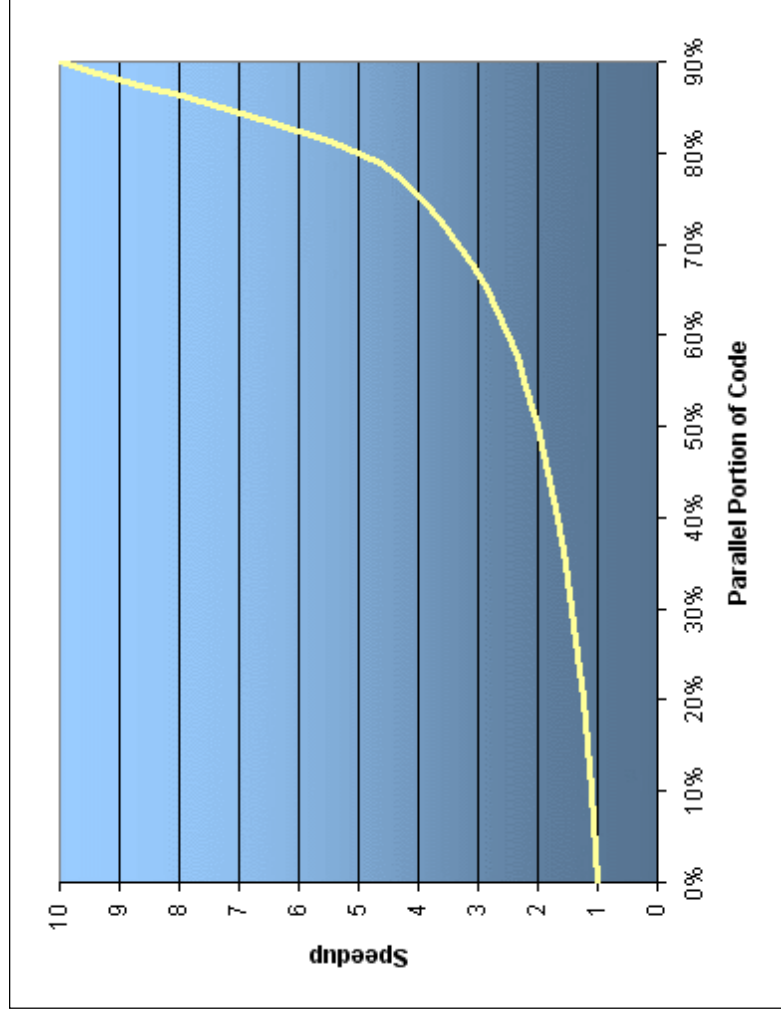

N	speedup		
	P = .50	P = .90	P = .99
10	1.82	5.26	9.17
100	1.98	9.17	50.25
1000	1.99	9.91	90.99
10000	1.99	9.91	99.02
100000	1.99	9.99	99.90

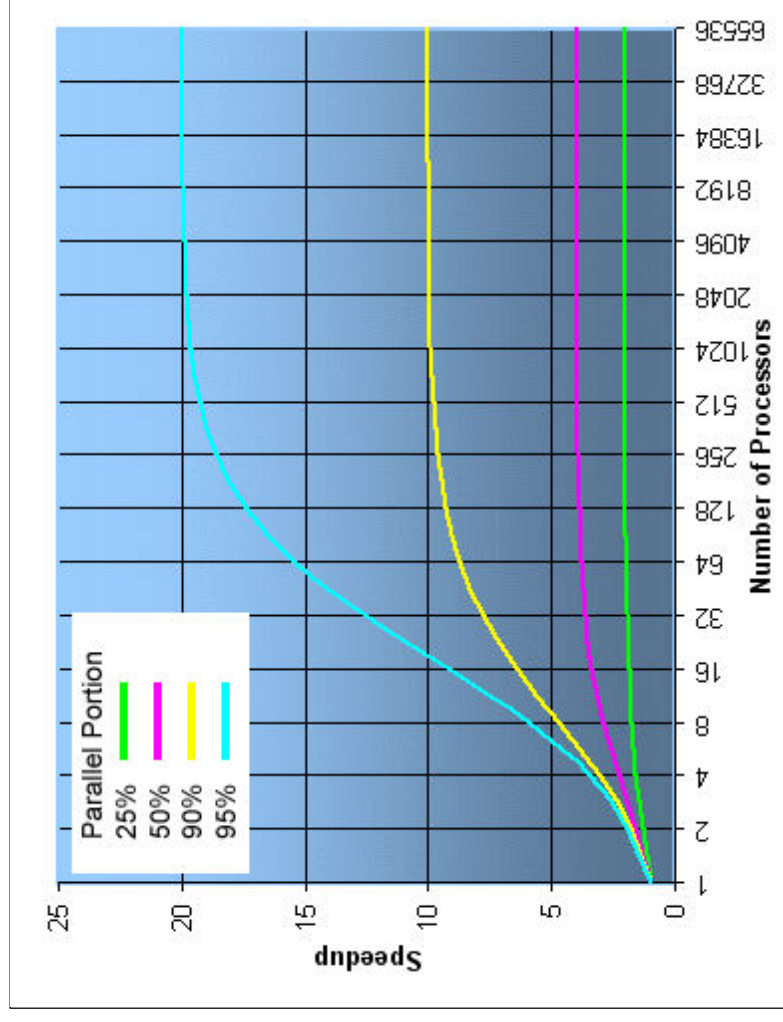

- However, certain problems demonstrate increased performance by increasing the problem size. For example:

2D Grid Calculations 85 seconds 85%
Serial fraction 15 seconds 15%

We can increase the problem size by doubling the grid dimensions and halving the time step. This results in four times the number of grid points and twice the number of time steps. The timings then look like:

2D Grid Calculations 680 seconds 97.84%
Serial fraction 15 seconds 2.16%

- Problems that increase the percentage of parallel time with their size are more *scalable* than problems with a fixed percentage of parallel time.

▲ Complexity:

- In general, parallel applications are much more complex than corresponding serial applications, perhaps an order of magnitude. Not only do you have multiple instruction streams executing at the same time, but you also have data flowing between them.

- The costs of complexity are measured in programmer time in virtually every aspect of the software development cycle:
 - Design
 - Coding
 - Debugging
 - Tuning
 - Maintenance
 - Adhering to "good" software development practices is essential when working with parallel applications - especially if somebody besides you will have to work with the software.
- ▶ **Portability:**
- Thanks to standardization in several APIs, such as MPI, POSIX threads, HPF and OpenMP, portability issues with parallel programs are not as serious as in years past. However...
 - All of the usual portability issues associated with serial programs apply to parallel programs. For example, if you use vendor "enhancements" to Fortran, C or C++, portability will be a problem.
 - Even though standards exist for several APIs, implementations will differ in a number of details, sometimes to the point of requiring code modifications in order to effect portability.
 - Operating systems can play a key role in code portability issues.
 - Hardware architectures are characteristically highly variable and can affect portability.

▶ **Resource Requirements:**

- The primary intent of parallel programming is to decrease execution wall clock time, however in order to accomplish this, more CPU time is required. For example, a parallel code that runs in 1 hour on 8 processors actually uses 8 hours of CPU time.
- The amount of memory required can be greater for parallel codes than serial codes, due to the need to replicate data and for overheads associated with parallel support libraries and subsystems.
- For short running parallel programs, there can actually be a decrease in performance compared to a similar serial implementation. The overhead costs associated with setting up the parallel environment, task creation, communications and task termination can comprise a significant portion of the total execution time for short runs.

▶ **Scalability:**

- The ability of a parallel program's performance to scale is a result of a number of interrelated factors. Simply adding more machines is rarely the answer.

- The algorithm may have inherent limits to scalability. At some point, adding more resources causes performance to decrease. Most parallel solutions demonstrate this characteristic at some point.
- Hardware factors play a significant role in scalability. Examples:
 - Memory-cpu bus bandwidth on an SMP machine
 - Communications network bandwidth
 - Amount of memory available on any given machine or set of machines
 - Processor clock speed
- Parallel support libraries and subsystems software can limit scalability independent of your application.

Designing Parallel Programs

Performance Analysis and Tuning

- As with debugging, monitoring and analyzing parallel program execution is significantly more of a challenge than for serial programs.
- A number of parallel tools for execution monitoring and program analysis are available.
- Some are quite useful; some are cross-platform also.
- Some starting points:
 - LC's "Supported Software and Computing Tools" web pages at: computing.llnl.gov/code/content/software_tools.php
 - A dated, but potentially useful LC whitepaper on the subject of "High Performance Tools and Technologies" describes a large number of tools, and a number of performance related topics applicable to code developers. Find it at: computing.llnl.gov/tutorials/performance_tools/HighPerformanceToolsTechnologiesLC.pdf.
 - [Performance Analysis Tools Tutorial](#)
- Work remains to be done, particularly in the area of scalability.

Parallel Examples

Array Processing

- This example demonstrates calculations on 2-dimensional array elements, with the computation on each array element being independent from other array elements.
- The serial program calculates one element at a time in sequential order.
- Serial code could be of the form:

```

do j = 1,n
do i = 1,n
  a(i,j) = fcn(i,j)
end do
end do

```

- The calculation of elements is independent of one another - leads to an embarrassingly parallel situation.
- The problem should be computationally intensive.

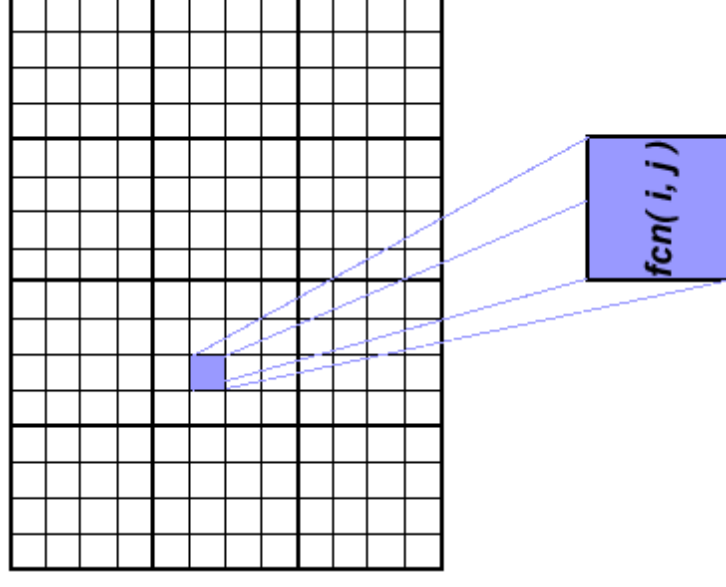

Array Processing Parallel Solution 1

- Arrays elements are distributed so that each processor owns a portion of an array (subarray).
- Independent calculation of array elements insures there is no need for communication between tasks.
- Distribution scheme is chosen by other criteria, e.g. unit stride (stride of 1) through the subarrays. Unit stride maximizes cache/memory usage.
- Since it is desirable to have unit stride through the subarrays, the choice of a distribution scheme depends on the programming language. See the [Block - Cyclic Distributions Diagram](#) for the options.
- After the array is distributed, each task executes the portion of the loop corresponding to the data it owns. For example, with Fortran block distribution:

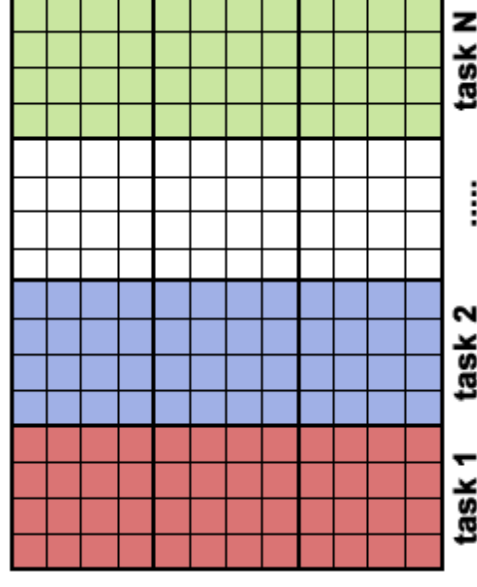

```
do j = mystart, myend
do i = 1,n
  a(i,j) = fcn(i,j)
end do
end do
```

- Notice that only the outer loop variables are different from the serial solution.

▶ One Possible Solution:

- Implement as SPMD model.
- Master process initializes array, sends info to worker processes and receives results.
- Worker process receives info, performs its share of computation and sends results to master.
- Using the Fortran storage scheme, perform block distribution of the array.
- Pseudo code solution: **red** highlights changes for parallelism.

```
find out if I am MASTER or WORKER
if I am MASTER
  initialize the array
  send each WORKER info on part of array it owns
  send each WORKER its portion of initial array
  receive from each WORKER results
else if I am WORKER
  receive from MASTER info on part of array I own
  receive from MASTER my portion of initial array
# calculate my portion of array
do j = my first column,my last column
do i = 1,n
  a(i,j) = fcn(i,j)
```

```

end do
end do
send MASTER results
endif

```

- [Example: MPI Program in C](#)
- [Example: MPI Program in Fortran](#)

Array Processing

Parallel Solution 2: Pool of Tasks

- The previous array solution demonstrated static load balancing:
 - Each task has a fixed amount of work to do
 - May be significant idle time for faster or more lightly loaded processors - slowest tasks determines overall performance.
- Static load balancing is not usually a major concern if all tasks are performing the same amount of work on identical machines.
- If you have a load balance problem (some tasks work faster than others), you may benefit by using a "pool of tasks" scheme.

▶ Pool of Tasks Scheme:

- Two processes are employed

Master Process:

- Holds pool of tasks for worker processes to do
- Sends worker a task when requested
- Collects results from workers

Worker Process: repeatedly does the following

- Gets task from master process
 - Performs computation
 - Sends results to master
- Worker processes do not know before runtime which portion of array they will handle or how many tasks they will perform.

- Dynamic load balancing occurs at run time: the faster tasks will get more work to do.
- Pseudo code solution: **red** highlights changes for parallelism.

```
find out if I am MASTER or WORKER
if I am MASTER
do until no more jobs
  send to WORKER next job
  receive results from WORKER
end do
tell WORKER no more jobs
else if I am WORKER
do until no more jobs
  receive from MASTER next job
  calculate array element: a(i,j) = fcn(i,j)
  send results to MASTER
end do
endif
```

Discussion:

- In the above pool of tasks example, each task calculated an individual array element as a job. The computation to communication ratio is finely granular.
- Finely granular solutions incur more communication overhead in order to reduce task idle time.
- A more optimal solution might be to distribute more work with each job. The "right" amount of work is problem dependent.

Parallel Examples

PI Calculation

- The value of PI can be calculated in a number of ways. Consider the following method of approximating PI
 1. Inscribe a circle in a square
 2. Randomly generate points in the square
 3. Determine the number of points in the square that are also in the circle
 4. Let r be the number of points in the circle divided by the number of points in the square
 5. $PI \sim 4r$
 6. Note that the more points generated, the better the approximation
- Serial pseudo code for this procedure:

```

npoints = 10000
circle_count = 0

do j = 1, npoints
  generate 2 random numbers between 0 and 1
  xcoordinate = random1
  ycoordinate = random2
  if (xcoordinate, ycoordinate) inside circle
    then circle_count = circle_count + 1
  end do

PI = 4.0*circle_count/npoints

```

- Note that most of the time in running this program would be spent executing the loop
- Leads to an embarrassing parallel solution
 - Computationally intensive
 - Minimal communication
 - Minimal I/O

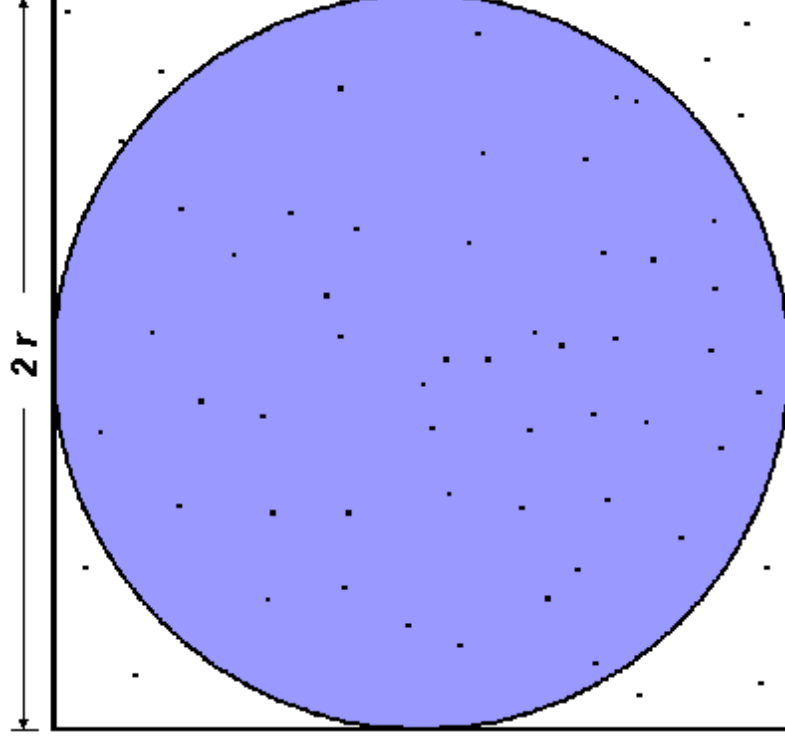

$$A_S = (2r)^2 = 4r^2$$

$$A_C = \pi r^2$$

$$\pi = 4 \times \frac{A_C}{A_S}$$

PI Calculation

Parallel Solution

- Parallel strategy: break the loop into portions that can be executed by the tasks.
- For the task of approximating PI:
 - Each task executes its portion of the loop a number of times.
 - Each task can do its work without requiring any information from the other tasks (there are no data dependencies).
 - Uses the SPMD model. One task acts as master and collects the results.
- Pseudo code solution: **red** highlights changes for parallelism.

```

npoints = 10000
circle_count = 0

p = number of tasks
num = npoints/p

find out if I am MASTER or WORKER

do j = 1, num
  generate 2 random numbers between 0 and 1
  xcoordinate = random1
  ycoordinate = random2
  if (xcoordinate, ycoordinate) inside circle
    then circle_count = circle_count + 1
  end do
if I am MASTER
  receive from WORKERS their circle_counts
  compute PI (use MASTER and WORKER calculations)
else if I am WORKER
  send to MASTER circle_count
endif

```

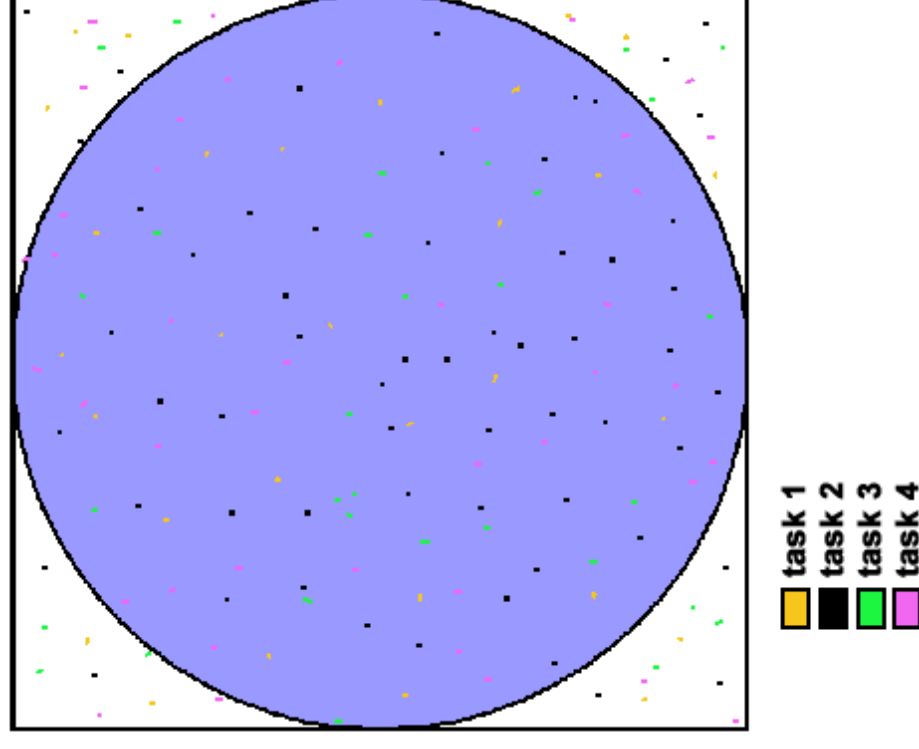

- [Example: MPI Program in C](#)
- [Example: MPI Program in Fortran](#)

Parallel Examples

Simple Heat Equation

- Most problems in parallel computing require communication among the tasks. A number of common problems require communication with "neighbor" tasks.
- The heat equation describes the temperature change over time, given initial temperature distribution and boundary conditions.
- A finite differencing scheme is employed to solve the heat equation numerically on a square region.
- The initial temperature is zero on the boundaries and high in the middle.
- The boundary temperature is held at zero.
- For the fully explicit problem, a time stepping algorithm is used. The elements of a 2-dimensional array represent the temperature at points on the square.
- The calculation of an element is dependent upon neighbor element values.

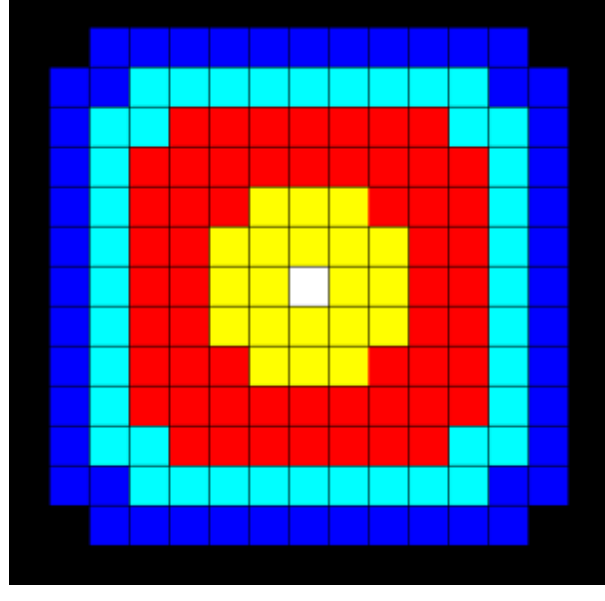

$$\begin{aligned}
 U_{x,y} = & U_{x,y} \\
 & + C_x * (U_{x+1,y} + U_{x-1,y} - 2 * U_{xy}) \\
 & + C_y * (U_{x,y+1} + U_{x,y-1} - 2 * U_{x,y})
 \end{aligned}$$

- A serial program would contain code like:

```

do iy = 2, ny - 1
do ix = 2, nx - 1
  u2(ix, iy) =
    u1(ix, iy) +
    cx * (u1(ix+1, iy) + u1(ix-1, iy) - 2.*u1(ix, iy)) +
    cy * (u1(ix, iy+1) + u1(ix, iy-1) - 2.*u1(ix, iy))
end do
end do

```

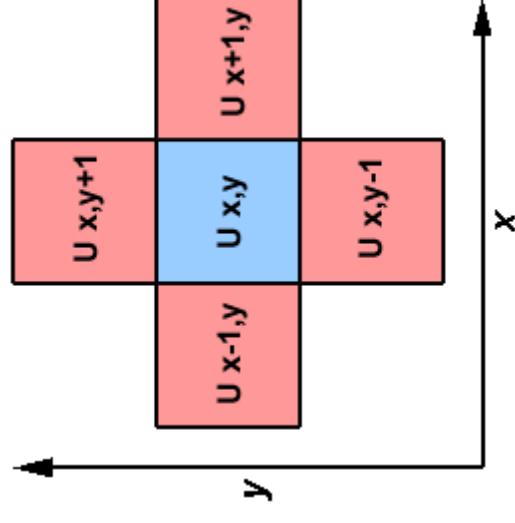

Simple Heat Equation Parallel Solution 1

- Implement as an SPMD model
- The entire array is partitioned and distributed as subarrays to all tasks. Each task owns a portion of the total array.
- Determine data dependencies
 - interior elements belonging to a task are independent of other tasks
 - border elements are dependent upon a neighbor task's data, necessitating communication.
- Master process sends initial info to workers, checks for convergence and collects results
- Worker process calculates solution, communicating as necessary with neighbor processes
- Pseudo code solution: **red** highlights changes for parallelism.

```

find out if I am MASTER or WORKER

```

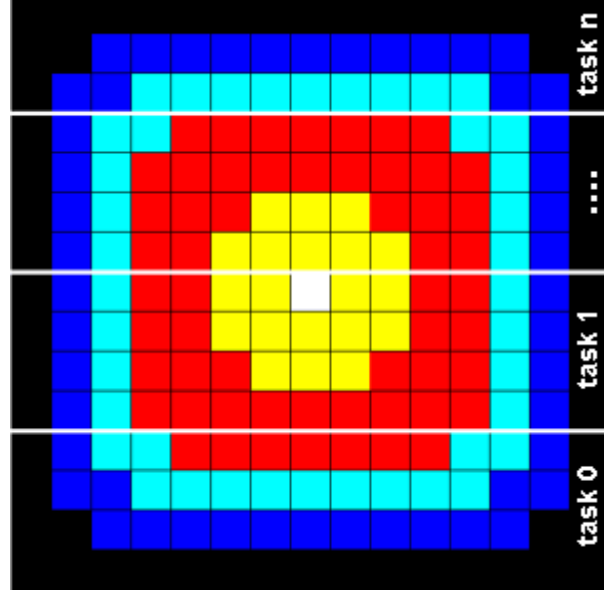

```
if I am MASTER
  initialize array
  send each WORKER starting info and subarray

do until all WORKERS converge
  gather from all WORKERS convergence data
  broadcast to all WORKERS convergence signal
end do

receive results from each WORKER

else if I am WORKER
  receive from MASTER starting info and subarray

do until solution converged
  update time
  send neighbors my border info
  receive from neighbors their border info

  update my portion of solution array

  determine if my solution has converged
  send MASTER convergence data
  receive from MASTER convergence signal
end do

send MASTER results
endif
```

- [Example: MPI Program in C](#)
- [Example: MPI Program in Fortran](#)

Simple Heat Equation

Parallel Solution 2: Overlapping Communication and Computation

- In the previous solution, it was assumed that blocking communications were used by the worker tasks. Blocking communications wait for the communication process to complete before continuing to the next program instruction.
- In the previous solution, neighbor tasks communicated border data, then each process updated its portion of the array.

- Computing times can often be reduced by using non-blocking communication. Non-blocking communications allow work to be performed while communication is in progress.
- Each task could update the interior of its part of the solution array while the communication of border data is occurring, and update its border after communication has completed.
- Pseudo code for the second solution: **red** highlights changes for non-blocking communications.

```
find out if I am MASTER or WORKER
if I am MASTER
  initialize array
  send each WORKER starting info and subarray
do until all WORKERS converge
  gather from all WORKERS convergence data
  broadcast to all WORKERS convergence signal
end do
receive results from each WORKER
else if I am WORKER
  receive from MASTER starting info and subarray
do until solution converged
  update time
non-blocking send neighbors my border info
non-blocking receive neighbors border info
update interior of my portion of solution array
wait for non-blocking communication complete
update border of my portion of solution array
determine if my solution has converged
  send MASTER convergence data
  receive from MASTER convergence signal
end do
send MASTER results
endif
```

Parallel Examples

1-D Wave Equation

- In this example, the amplitude along a uniform, vibrating string is calculated after a specified amount of time has elapsed.
- The calculation involves:
 - the amplitude on the y axis
 - i as the position index along the x axis
 - node points imposed along the string
 - update of the amplitude at discrete time steps.

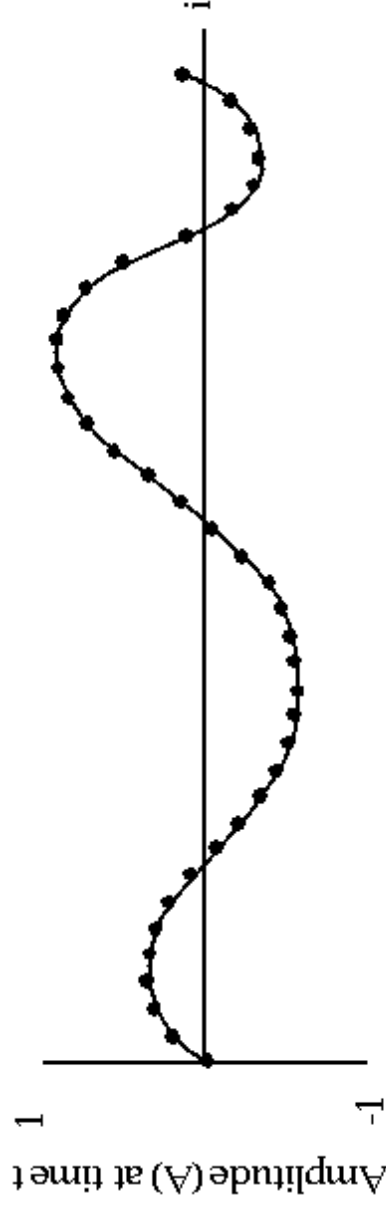

Position index (i)

- The equation to be solved is the one-dimensional wave equation:

$$A(i, t+1) = (2.0 * A(i, t)) - A(i, t-1) + (c * (A(i-1, t) - (2.0 * A(i, t)) + A(i+1, t)))$$

where c is a constant

- Note that amplitude will depend on previous timesteps ($t, t-1$) and neighboring points ($i-1, i+1$). Data dependence will mean that a parallel solution will involve communications.

1-D Wave Equation Parallel Solution

- Implement as an SPMD model
- The entire amplitude array is partitioned and distributed as subarrays to all tasks. Each task owns a portion of the total array.
- Load balancing: all points require equal work, so the points should be divided equally
- A block decomposition would have the work partitioned into the number of tasks as chunks, allowing each task to own mostly contiguous data points.
- Communication need only occur on data borders. The larger the block size the less the communication.

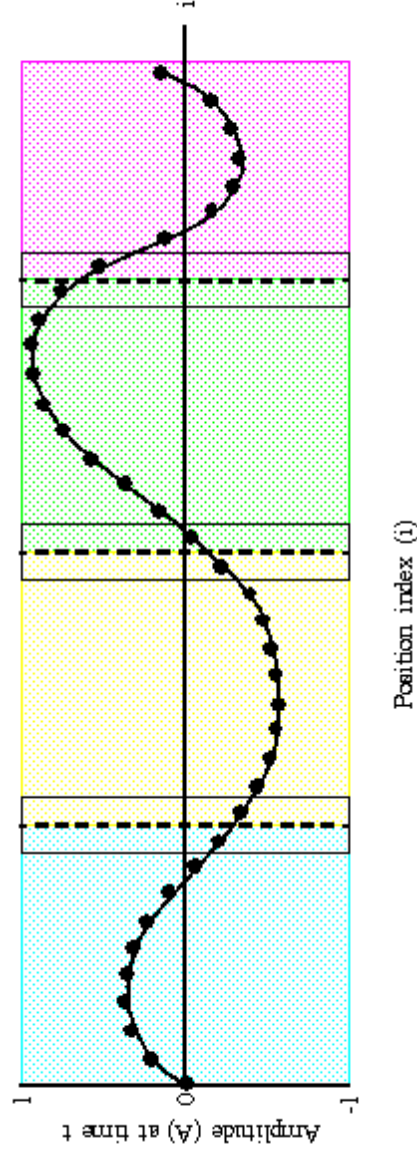

- Pseudo code solution:

```

find out number of tasks and task identities
#Identify left and right neighbors
left_neighbor = mytaskid - 1
right_neighbor = mytaskid + 1
if mytaskid = first then left_neighbor = last
if mytaskid = last then right_neighbor = first

find out if I am MASTER or WORKER
if I am MASTER
    initialize array
    send each WORKER starting info and subarray
else if I am WORKER
    receive starting info and subarray from MASTER

```

```
endif

#Update values for each point along string
#In this example the master participates in calculations
do t = 1, nsteps
  send left endpoint to left neighbor
  receive left endpoint from right neighbor
  send right endpoint to right neighbor
  receive right endpoint from left neighbor

#Update points along line
do i = 1, npoints
  newval(i) = (2.0 * values(i)) - oldval(i)
  + (sqrtau * (values(i-1) - (2.0 * values(i)) + values(i+1)))
end do

end do

#Collect results and write to file
if I am MASTER
  receive results from each WORKER
  write results to file
else if I am WORKER
  send results to MASTER
endif
```

- [Example: MPI Program in C](#)
- [Example: MPI Program in Fortran](#)

This completes the tutorial.



Please complete the online evaluation form.

Where would you like to go now?

- [Agenda](#)
- [Back to the top](#)

References and More Information

- Author: [Blaise Barney](#), Livermore Computing.
- A search on the WWW for "parallel programming" or "parallel computing" will yield a wide variety of information.
- Recommended reading:
 - "Designing and Building Parallel Programs" . Ian Foster.
<http://www-unix.mcs.anl.gov/dbpp/>
 - "Introduction to Parallel Computing" . Ananth Grama, Anshul Gupta, George Karypis, Vipin Kumar.
<http://www-users.cs.umn.edu/~karypis/parbook/>
 - "Overview of Recent Supercomputers" . A.J. van der Steen, Jack Dongarra.
www.phys.uu.nl/~steen/web03/overview.html
- Photos/Graphics have been created by the author, created by other LLNL employees, obtained from non-copyrighted, government or public domain (such as <http://commons.wikimedia.org/>) sources, or used with the permission of authors from other presentations and web pages.
- History: These materials have evolved from the following sources, which are no longer maintained or available.
 - Tutorials located in the Maui High Performance Computing Center's "SP Parallel Programming Workshop" .
 - Tutorials located at the Cornell Theory Center's "Education and Training" web page.

file:///C:/Documents%20and%20Settings/aproenca/Desktop/CourseIntroParallelComp/Introduction%20to%20Parallel%20Computing.htm
Last Modified: 10/08/2009 14:39:57 blaiseb@llnl.gov
UCRL-MI-133316

https://computing.llnl.gov/tutorials/parallel_comp/
Last Modified: 01/26/2009 20:33:29 blaiseb@llnl.gov
UCRL-MI-133316

